



**maxema<sup>®</sup>**

**CATALOGUE 2021**



Made  
in Italy



Prodotto  
in Italia



Fabriqué  
en Italie



Fabricado  
en Italia

# Contents

## Indice

**More than plastic.** 07

**Maxema Antibacterial Pens**  08

**Dot – Antibacterial**  14

retractable / meccanismo a scatto  
D1-MATT CB AB

**Flow Pure – Antibacterial**  16

twist-action / meccanismo a rotazione  
F2P-C AB

**Zink – Antibacterial**  17

twist-action / meccanismo a rotazione  
Z1-C AB

**Pixel – Antibacterial**  18

retractable / meccanismo a scatto  
PX40-MATT CB AB

**Bay – Antibacterial**  19

twist-action / meccanismo a rotazione  
B500-C AB

**Maxema Recycled Antibacterial Pens**  20

**Tag Green Antibacterial**  26

twist-action / meccanismo a rotazione  
TA2-C AB RE

**Icon Green Antibacterial**  30

twist-action / meccanismo a rotazione  
IG2-C AB RE

**Maxema Recycled** 34

**Icon Pure – Recycled**  40

twist-action / meccanismo a rotazione  
IC8 – MATT RE

**Flow Pure – Recycled**  44

twist-action / meccanismo a rotazione  
F2P – MATT CB RE 46  
F2P – MATT RE 48

**Dot – Recycled**  50

retractable / meccanismo a scatto  
D1 – MATT CB RE 52  
D1 – MATT RE 54

**Zink – Recycled**  56

twist-action / meccanismo a rotazione  
Z1 – CB RE 58  
Z1 – C RE 60

**Pixel – Recycled**  62

retractable / meccanismo a scatto  
PX40 – MATT CB RE 64  
PX40 – MATT RE 66

**Bay – Recycled**  68

twist-action / meccanismo a rotazione  
B500 – MATT RE 70

**Mood Metal**  74

retractable / meccanismo a scatto  
MD1 – M M1 76  
MD1 – M M4 78  
MD1 – M M2 80

**Mood**  82

retractable / meccanismo a scatto  
MD1 – C M1 84  
MD1 – GOM CB M1 86  
MD1 – GOM C M1 88  
MD1 – GOM 30 M1 90  
MD1 – C M2 92  
MD1 – C M3 93

**Icon Pure** 94

twist-action / meccanismo a rotazione  
IC8 – GOM 96

**Flow Pure** 98

twist-action / meccanismo a rotazione  
F2P – GOM MATT 100  
F2P – MATT CB 102  
F2P – MATT 104  
F2P – MATT F 106

F2P – C 108  
F2P – GOM K 110  
F2P – GOM CB 112  
F2P – GOM 30 114  
F2P – GOM CF 116  
F2P – GOM KF 117  
F2P – GOM 30 F 118

**Flow** 120

twist-action / meccanismo a rotazione  
F1 – MATT AL 122  
F1 – C CR 124  
F1T – GOM C CR 126  
F1T – GOM CB CR 128  
F1T – GOM 30 CR 130

**Dot** 132

retractable / meccanismo a scatto  
D1 – MATT B 134  
D1 – MATT CB 136  
D1 – MATT 138  
D1 – MATT K 140  
D1 – MATT F 142  
D1 – B CR 144  
D1 – CB CR 146  
D1 – C CR 148  
D1 – 30 CR 150  
D1 – GOM K 152  
D1 – GOM CB CR 154  
D1 – GOM C CR 156  
D1 – GOM 30 CR 158  
D1 – C GOLD 160  
D1 – GOM KF CR 161

**Zink** 162

twist-action / meccanismo a rotazione  
Z1 – CB 164  
Z1 – C 166  
Z1 – 30 168  
Z1 – CF 170

**View** 172

twist-action / meccanismo a rotazione  
V1 – C CR / V1 – C CR T 174  
V1 – 30 CR / V1 – 30 CR T 176  
V1 – AL CR / V1 – AL CR T 177  
V1 – GOM C CR / 178  
V1 – GOM C CR T

**Tag** 180

twist-action / meccanismo a rotazione  
TA1 – MATT AL B 182

TA1 – B CR 184  
TA1 – C CR 186  
TA1 – MET AL 188  
TA1 – AL CR 189

**Icon** 190

twist-action / meccanismo a rotazione  
IC400 – MATT 192  
IC400 – FROST 193  
IC400 – MATT AL 194  
IC400 – C CR 196  
IC400 – FROST AL 198  
IC400 – 30 CR 199  
IC400 – C GOLD 200  
IC400 – MET AL 201  
IC400 – AL CR 201

**Tag green** 202

twist-action / meccanismo a rotazione  
TA2 – B 206  
TA2 – BC 207

**Icon green** 208

twist-action / meccanismo a rotazione  
IG2 – BC 212  
IG2 – C 213

**Ethic** 214

twist-action / meccanismo a rotazione  
ET900 – MULTICOLOUR 216  
ET900 – FLAG 217  
ET900 – C FLAG 217  
ET900 – B 218  
ET900 – BC 219  
ET900 – C CR 220  
ET900 – C GOLD 221  
ET900 – AL 222  
ET900 – AL CR 223  
ET900 – AL FLAG 223  
ET900 – MET CR 224  
ET900 – MET AL 225

**Next** 226

retractable / meccanismo a scatto  
NX400 – C CR 228  
NX400 – 30 CR 229

**Pixel** 230

retractable / meccanismo a scatto  
PX40 – MATT CB 232  
PX40 – MATT CR 234

PX40 – B 236  
PX40 – C 237  
PX40 – 30 238  
PX40 – FROST NEUTRAL 239  
PX40 – FROST 240  
PX40 – GOM C CR 242  
PX40 – GOM 30 CR 243

**Bay** 244

twist-action / meccanismo a rotazione  
B500 – MATT BC 246  
B500 – MATT 248  
B500 – BC 250  
B500 – C 251  
B500 – 30 252  
B500 – FROST 253

**Technical information** 254

informazioni tecniche

**Packaging** 274

**Sales support** 280

supporti di vendita

**Inks and refills** 288

inchiostri e refill

**Finishes** 290

finiture

**Colour palette** 291

palette color

# More than plastic.

EN

---

Those who know us are well aware that our pens are much more than just plastic. We have been working in Italy for two generations alongside people we trust and with whom we love to design top quality writing implements. Each Maxema pen is created from the desire to take care of the environment and our customers, with safe, reliable and durable materials. Our mission? To support your projects and help you, wherever you may be in the world, to tell your story and leave a lasting message.

IT

---

Chi ci conosce lo sa bene, le nostre penne sono molto più che semplice plastica. Da oltre due generazioni lavoriamo in Italia a fianco di persone di cui ci fidiamo e con le quali amiamo creare strumenti di scrittura di altissima qualità.

Ogni penna Maxema nasce dalla voglia di prenderci cura dell'ambiente e dei nostri clienti, con materiali sicuri, affidabili e duraturi. La nostra missione? Sostenere i tuoi progetti e aiutarti, in qualsiasi parte del mondo, a raccontare la tua storia e lasciare un messaggio che duri nel tempo.



TAKE IT  
SAFE,  
TAKE IT  
EASY.

ANTIBACTERIAL PENS

NEW

Take care of yourself even when you write: the plastic we use for our Antibacterial collection prevents bacteria from settling on pen surfaces and passing from one hand to the other.

—  
*Anche quando scrivi,  
prenditi cura di te:  
la plastica che usiamo  
per la nostra collezione  
Antibacterial impedisce  
ai batteri di depositarsi  
sulle superfici della penna  
e passare da una mano  
all'altra.*

Solo penne, niente batteri

NEW

# JUST PENS, NO BACTERIA.

EN

We need to feel protected, every day and today even more so. Maxema Antibacterial is our new collection of antibacterial pens, able to combine design and safety. Due to a special ISO 22196:2011 certified antimicrobial additive, the plastic releases silver ions that destroy up to 99,99% of the bacteria present on the pen.

## Take it safe, take it easy

In the office, at the bar, in public places: has it ever crossed your mind how many microbes pass from hand to hand through the most everyday actions? Our antibacterial pens, combined with good hygiene habits, guarantee an additional level of protection.

IT

Abbiamo bisogno di sentirci protetti, ogni giorno e oggi ancora di più. Maxema Antibacterial è la nostra nuova collezione di penne antibatteriche, in grado di unire design e sicurezza. La plastica, grazie a uno speciale additivo antimicrobico certificato ISO 22196:2011, rilascia ioni d'argento che distruggono fino al 99,99% dei batteri presenti sulla penna.

## Solo penne, niente batteri

In ufficio, al bar, nei luoghi pubblici: hai mai pensato a quanti microbi passano di mano in mano attraverso i gesti più quotidiani? Le nostre penne antibatteriche, abbinata a buone abitudini igieniche, garantiscono un ulteriore livello di protezione.

TAKE IT  
SAFE,  
TAKE IT  
EASY.

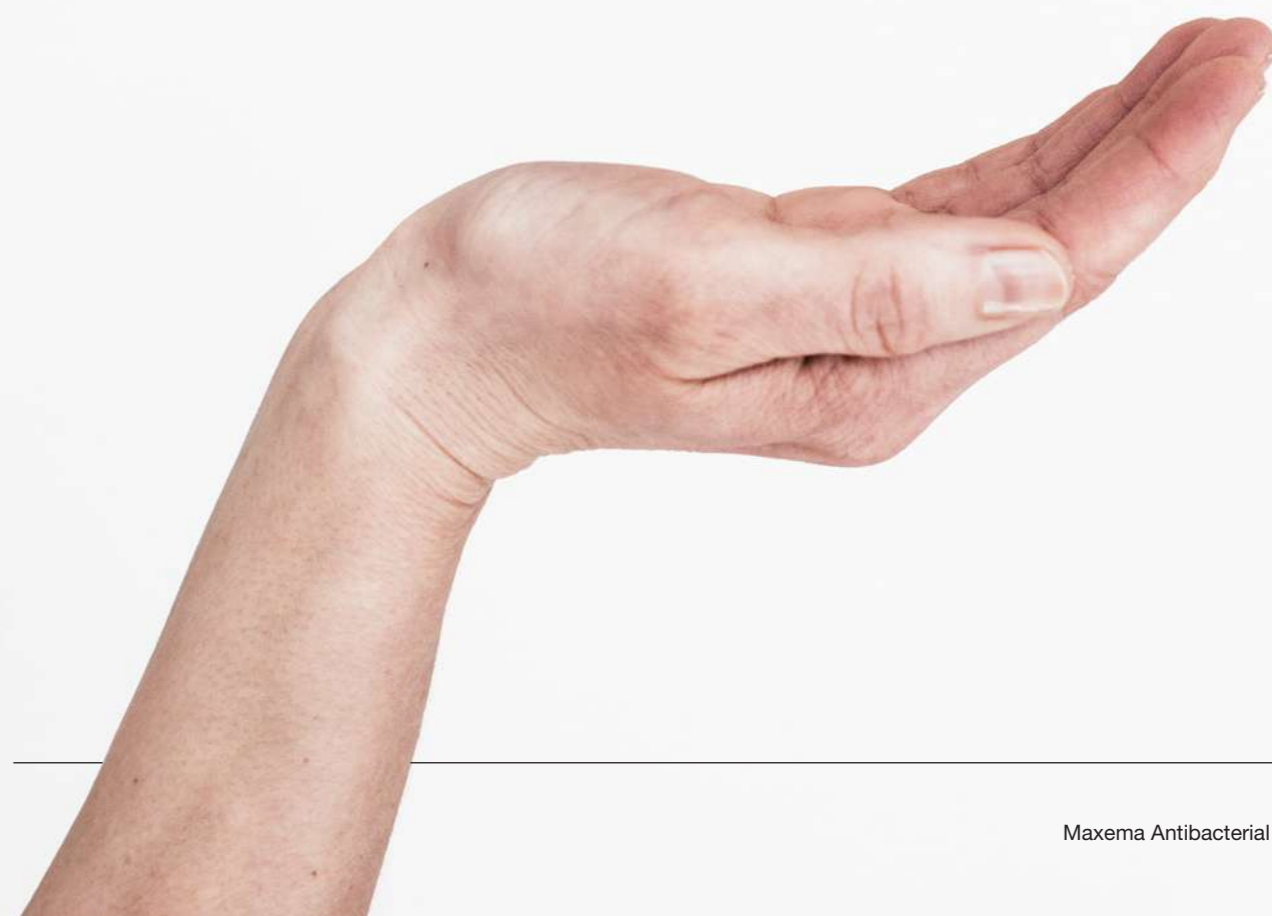
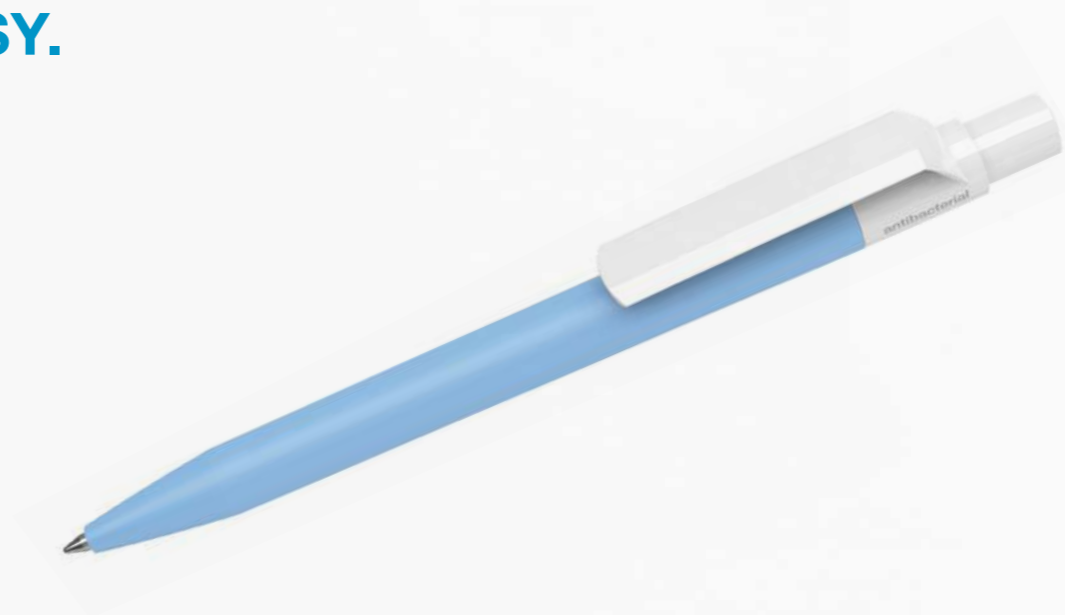

NEW

# WHY CHOOSE MAXEMA ANTIBACTERIAL



EN

## The plastic used is antibacterial

A special ISO 22196:2011 certified antimicrobial additive releases silver ions and prevents bacteria from settling on the surfaces of the pen.

IT

## La plastica è antibatterica

Uno speciale additivo antimicrobico certificato ISO 22196:2011 rilascia ioni d'argento e impedisce ai batteri di depositarsi sulle superfici della penna.



## Bacteria: up to 99,99% less

Laboratory tests have shown that up to 99,99% of the bacteria on the pen are destroyed.

## Batteri: fino al 99,99% in meno

I test condotti in laboratorio dimostrano che i batteri presenti sulla penna vengono distrutti fino al 99,99%.



## We care about your health

Some bacteria can cause disease and infections: make your life still safer, even when you write.

## Abbiamo a cuore la tua salute

Alcuni batteri possono causare malattie e infezioni: rendi la tua vita ancora più sicura, anche quando scrivi.

Gli ioni d'argento eliminano  
fino al 99,99% dei batteri

# SILVER IONS ELIMINATE UP TO 99,99% OF BACTERIA

EN

A special ISO 22196:2011 certified additive that releases silver ions is added to the ABS plastic we use for our Antibacterial pens: the ions settle on the cell walls of bacteria and inhibit their survival and reproduction. The antibacterial effectiveness is confirmed by meticulous evaluation tests.

Microorganisms are inoculated in a sample of material and the surface is covered with a fine sterile film that promotes the spread of the bacteria, prevents evaporation and ensures contact with the antimicrobial surface.

After incubating for 24 hours at 37°C, the microbe concentrations are measured, and the reduction in microorganisms compared to the initial concentrations calculated. The 99,99% reduction in bacteria results in a good antimicrobial effect.

IT

Alla plastica ABS che usiamo per le nostre penne Antibacterial viene aggiunto un particolare additivo antimicrobico certificato ISO 22196:2011 che rilascia ioni d'argento: questi si depositano sulle pareti cellulari dei batteri e ne inibiscono la sopravvivenza e la riproduzione. L'efficacia antibatterica è confermata da accurati test di valutazione.

Su un campione di materiale vengono inoculati i microrganismi e la superficie viene coperta con una sottile pellicola sterile che favorisce la diffusione batterica, ne impedisce l'evaporazione e garantisce il contatto con la superficie antimicrobica.

Dopo l'incubazione per 24 ore a 37°C, vengono misurate le concentrazioni microbiche, calcolando la riduzione dei microrganismi rispetto alle concentrazioni iniziali. La riduzione del 99,99% dei batteri determina un buon effetto antimicrobico.

Test organisms / Organismi di prova	Bacteriostatic activity R / Attività batteriostatica R	Percentage reduction / Riduzione percentuale	Evaluation / Valutazione
Staphylococcus aureus (ATCC 33592)	1	up to 99,99% / fino al 99,99%	Good antimicrobial effect / Buon effetto antimicrobico

**DOT ANTIBACTERIAL**  
D1-MATT CB AB

Antibacterial plastic, solid colour barrel with matt finish, solid glossy white clip, push-button and little sphere

NEW



01



15 red / pad printing 40 x 9 mm  
15 rosso / tampografia 40 x 9 mm

25 dark violet / pad printing 40 x 9 mm  
25 viola scuro / tampografia 40 x 9 mm



Plastica antibatterica, fusto in colore coprente con finitura satinata, clip, tappino e piccola sfera in colore bianco coprente lucido

solid / coprenti

01 white bianco	03 yellow giallo	18 orange arancio	15 red rosso
74 burgundy bordeaux	60 pink rosa	61 magenta magenta	71 light violet viola chiaro
25 dark violet viola scuro	79 lime lime	09 green verde	75 dark green verde scuro
26 aquamarine acquamarina	27 ocean green ottanio	64 pastel blue azzurro pastello	77 cyan ciano
12 light blue azzurro	22 blue blu	05 grey grigio	04 black nero

Technical information at p. 263  
Informazioni tecniche a pag. 263



## FLOW PURE ANTIBACTERIAL F2P-C AB

Antibacterial plastic, solid white colour  
with glossy finish

–  
*Plastica antibatterica, colore bianco  
coprente con finitura lucida*

NEW

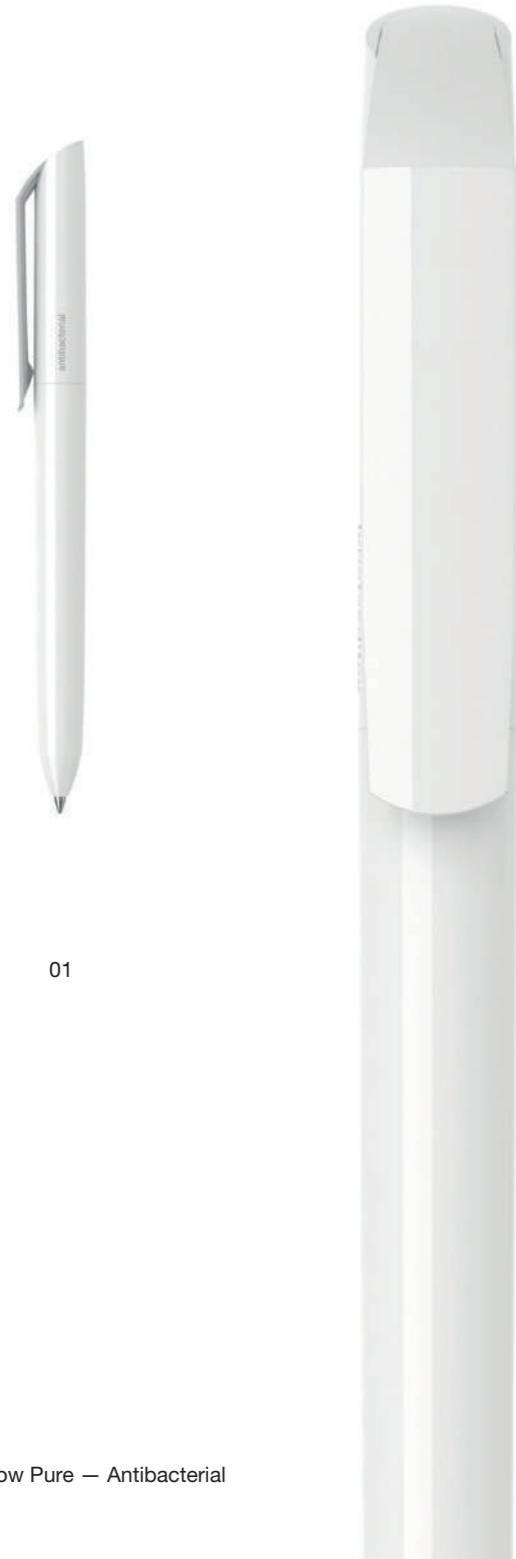

01

solid / coprenti

01  
white  
bianco

Technical information at p. 261  
*Informazioni tecniche a pag. 261*

## ZINK ANTIBACTERIAL Z1-C AB

Antibacterial plastic, solid white colour  
with glossy finish

–  
*Plastica antibatterica, colore bianco  
coprente con finitura lucida*

NEW



01

solid / coprenti

01  
white  
bianco

Technical information at p. 264  
*Informazioni tecniche a pag. 264*

## PIXEL ANTIBACTERIAL PX40-MATT CB AB

Antibacterial plastic, solid white colour  
barrel with matt finish, solid glossy  
white clip and push-button

–  
*Plastica antibatterica, fusto in colore  
bianco coprente con finitura  
satinata, clip e tappino in colore  
bianco coprente lucido*

NEW



01



solid / coprenti

01

white  
bianco

Technical information at p. 272  
*Informazioni tecniche a pag. 272*

## BAY ANTIBACTERIAL B500-C AB

Antibacterial plastic, solid white colour  
with glossy finish

–  
*Plastica antibatterica, colore bianco  
coprente con finitura lucida*

NEW



01



solid / coprenti

01

white  
bianco

Technical information at p. 273  
*Informazioni tecniche a pag. 273*



RECYCLED ANTIBACTERIAL  
PENS

NEW

Safety meets sustainability:  
discover our recycled plastic  
antibacterial pens with the  
Jumbo refill designed to last  
even longer.

—  
*La sicurezza incontra  
la sostenibilità: scopri le  
nostre penne antibatteriche  
in plastica riciclata, con il  
refill Jumbo pensato per  
durare ancora più a lungo.*

Doppia protezione,  
per te e per l'ambiente

# DOUBLE PROTECTION, FOR YOU AND THE ENVIRONMENT

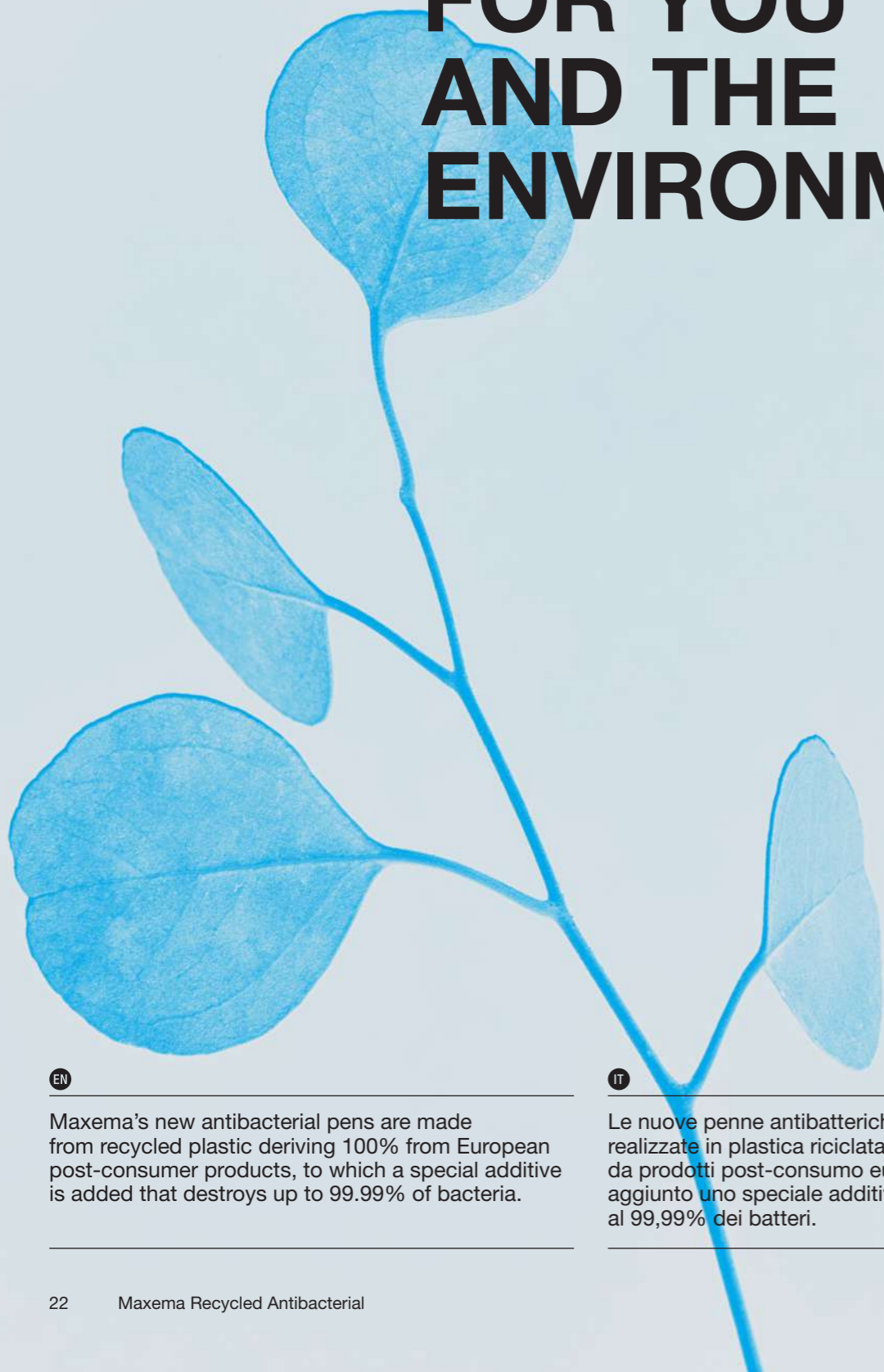

EN

Maxema's new antibacterial pens are made from recycled plastic deriving 100% from European post-consumer products, to which a special additive is added that destroys up to 99.99% of bacteria.

IT

Le nuove penne antibatteriche Maxema sono realizzate in plastica riciclata derivante al 100% da prodotti post-consumo europei, a cui viene aggiunto uno speciale additivo che distrugge fino al 99,99% dei batteri.



Una penna sostenibile  
e duratura

NEW

# A SUSTAINABLE AND DURABLE PEN

EN

Recycled plastic, Jumbo refill and silver ions:  
the right combination for safe living, having more ink  
to write with and for saving the planet.









IT

Plastica riciclata, refill Jumbo e ioni d'argento:  
la combinazione giusta per vivere in modo sicuro,  
avere più inchiostro per scrivere e salvaguardare  
il pianeta.

La sicurezza,  
in tutte le sue sfumature

# SAFETY, IN ALL ITS NUANCES

solid / coprenti

06		ICE	10		CLOUD
76		DESERT	87		MUD
19		FOREST	21		ABYSS
58		GRAPHITE	07		ONYX

# Tag Green Antibacterial

△ RECYCLED

Objective: total safety.  
*Obiettivo: sicurezza totale.*

Design that combines safety and environment friendliness.

*Il design sposa la sicurezza e rispetta l'ambiente.*

NEW



QUALITY NOT QUANTITY

The entire Maxema collection is available in recycled plastic on request /  
*Tutta la collezione Maxema è realizzabile in plastica riciclata su richiesta*

Technical information at p. 256  
*Informazioni tecniche a pag. 256*

Recycled antibacterial plastic  
Solid colours with glossy finish

Recycled  
and antibacterial:  
the new plastic  
that takes care  
of you and  
the environment

NEW



10

76

87

06 ice / pad printing 35 x 7 mm  
tampografia 35 x 7 mm

Plastica riciclata antibatterica  
Colori coprenti con finitura lucida

Riciclata  
e antibatterica:  
la nuova plastica  
che si prende  
cura di te  
e dell'ambiente



19

21

58

07



**MY BOX RECYCLED**

Universal reclosable single pen box  
in recycled Fedrigoni paper.  
Info at p. 278

*Astuccio universale richiudibile per penna  
singola in cartoncino riciclato Fedrigoni.  
Info pag. 278*

# Icon Green Antibacterial

△ RECYCLED

People and environment friendly.  
*Nel rispetto dell'uomo e della natura.*

Testimony of an  
enduring message.

*Testimone di un  
messaggio destinato  
a durare nel tempo.*

NEW

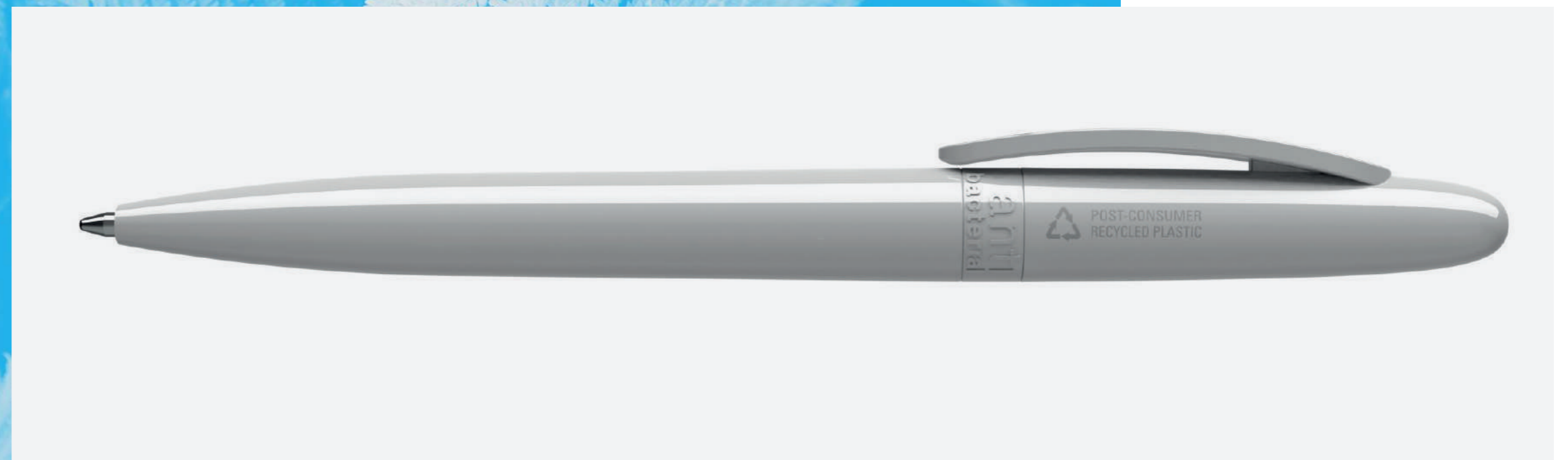

QUALITY NOT QUANTITY

The entire Maxema collection is available in recycled plastic on request /  
*Tutta la collezione Maxema è realizzabile in plastica riciclata su richiesta*

Technical information at p. 257  
*Informazioni tecniche a pag. 257*



Recycled antibacterial plastic  
Solid colours with glossy finish

NEW



06



HIDDENFJORD  
RAISED IN THE WILD

10 cloud / screen printing 40 x 30 mm  
serigrafia 40 x 30 mm



76



87



19



21



58



07

Plastica riciclata antibatterica  
Colori coprenti con finitura lucida



**MY BOX RECYCLED**

Universal reclosable single pen box  
in recycled Fedrigoni paper.  
Info at p. 278

*Astuccio universale richiudibile per penna  
singola in cartoncino riciclato Fedrigoni.  
Info pag. 278*



## RECYCLED PENS

Change is a choice and it depends on each of us. To change means to choose responsible, sustainable consumption that prefers quality to quantity, better still if the raw materials come from recovery chains.

—  
*Il cambiamento è una scelta e dipende da ognuno di noi. Cambiare significa scegliere un consumo responsabile e sostenibile che prediliga la qualità, meglio se con l'impiego di materie prime provenienti da filiere di recupero.*

Scegli un prodotto che dura nel tempo.

# CHOOSE BETTER. MAKE IT LAST.

EN

Who said good things don't last? At Maxema, we do everything we can to make our pens live for as long as possible. A Maxema pen loves nature: the longer it lasts, the less it pollutes. And, since one life seemed too short for us, we have created a new line in recycled plastic, beautiful to look at and even more environmentally friendly. All our pens can be made of recycled plastic: choose your favourite model, inspired by the colours of Nature.

IT

Chi l'ha detto che le cose belle durano poco? Noi di Maxema ce la mettiamo tutta per far vivere le nostre penne il più a lungo possibile. Una penna Maxema ama la natura: più tempo dura, meno inquina. E, visto che una vita sola ci sembrava troppo breve, abbiamo realizzato una nuova linea in plastica riciclata, bella da vedere e ancora più attenta all'ambiente. Tutte le nostre penne possono essere realizzate in plastica riciclata: scegli il tuo modello preferito, ispirato ai colori della natura.



Una vita sola non basta.

# ONE LIFE IS TOO SHORT.

EN

## Why use plastic only once when it can be turned into something new?

For our recycled plastic pens we use materials of European origin that are 100% derived from post-consumer products. When appropriately treated, these guarantee high quality plastics, certified and compliant with RoHS and REACH regulations.

IT









## Perché usare la plastica una volta sola quando può trasformarsi in qualcosa di nuovo?

Per le nostre penne in plastica riciclata usiamo materiali di origine europea derivanti al 100% da prodotti post-consumo che, opportunamente trattati, garantiscono materie plastiche di elevata qualità, certificate e conformi alle normative RoHS e REACH.

La Terra è piena di sfumature.

# THE EARTH IS FULL OF COLOURS.

solid / coprenti

06		ICE	10		CLOUD
76		DESERT	87		MUD
19		FOREST	21		ABYSS
58		GRAPHITE	07		ONYX

# Icon Pure

△ RECYCLED

The purity of simplicity.  
*La purezza della semplicità.*

All-round personality.  
*Personalità a tutto tondo.*



QUALITY NOT QUANTITY

The entire Maxema collection is available in recycled plastic on request /  
*Tutta la collezione Maxema è realizzabile in plastica riciclata su richiesta*

Technical information at p. 260  
*Informazioni tecniche a pag. 260*

Recycled plastic  
Solid colours with matt finish

Design embraces  
sustainability.



06

10

76

87 mud / pad printing 35 x 7 mm  
tampografia 35 x 7 mm

Plastica riciclata  
Colori coprenti con finitura satinata

Il design abbraccia  
la sostenibilità.



19

21

58

07 onyx / pad printing 35 x 7 mm  
tampografia 35 x 7 mm



**MY BOX RECYCLED**

Universal reclosable single pen box  
in recycled Fedrigoni paper.  
Info at p. 278

*Astuccio universale richiudibile per penna  
singola in cartoncino riciclato Fedrigoni.  
Info pag. 278*

# Flow Pure

△ RECYCLED

Free from extra.  
*Pura ed essenziale.*

The essence of design.  
*L'essenza del design.*



QUALITY NOT QUANTITY

The entire Maxema collection is available in recycled plastic on request /  
*Tutta la collezione Maxema è realizzabile in plastica riciclata su richiesta*

Technical information at p. 261  
*Informazioni tecniche a pag. 261*

Recycled plastic  
Solid colour barrel and cap, solid white  
colour clip, matt finish



10



76



87 mud / pad printing 40 x 9 mm  
tampografia 40 x 9 mm



19



21



58



07 onyx / pad printing 40 x 9 mm  
tampografia 40 x 9 mm

Plastica riciclata  
Fusto e cappuccio in colore coprente,  
clip in colore bianco coprente,  
finitura satinata

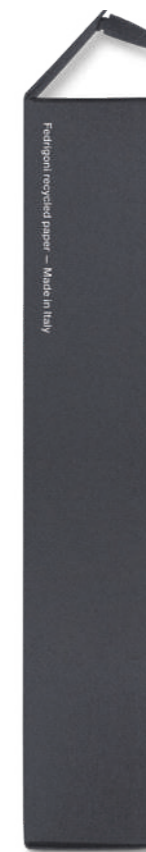

**MY BOX RECYCLED**

Universal reclosable single pen box  
in recycled Fedrigoni paper.  
Info at p. 278

*Astuccio universale richiudibile per penna  
singola in cartoncino riciclato Fedrigoni.  
Info pag. 278*



Recycled plastic  
Solid colours with matt finish

For responsible  
consumption:  
more quality, less  
quantity.



10 cloud / pad printing 40 x 9 mm  
tampografia 40 x 9 mm

Plastica riciclata  
Colori coprenti con finitura satinata

Per un consumo  
responsabile: più  
qualità, meno  
quantità.



19 forest / pad printing 40 x 9 mm  
tampografia 40 x 9 mm

# Dot

△ RECYCLED

Different from the rest, full stop.  
*Diversa da tutte, punto.*

A pen that reveals its originality in its details.

*È nei dettagli che rivela la sua originalità.*



QUALITY NOT QUANTITY

The entire Maxema collection is available in recycled plastic on request /  
*Tutta la collezione Maxema è realizzabile in plastica riciclata su richiesta*

Technical information at p. 263  
*Informazioni tecniche a pag. 263*

Recycled plastic  
Solid colour barrel with matt finish,  
solid matt white clip and push-button,  
solid glossy white little sphere



10



76



87



**MY BOX RECYCLED**

Universal reclosable single pen box  
in recycled Fedrigoni paper.  
Info at p. 278

*Astuccio universale richiudibile per  
penna singola in cartoncino riciclato  
Fedrigoni.  
Info pag. 278*



19



58



07

21 abyss / pad printing 40 x 9 mm  
tampografia 40 x 9 mm

Plastica riciclata  
Fusto in colore coprente con finitura  
satinata, clip e tappino in colore  
bianco coprente satinato, piccola  
sfera in colore bianco coprente lucido

Recycled plastic  
Solid colours with matt finish,  
solid glossy colour little sphere

The beauty  
of sustainability:  
8 colour  
shades inspired  
by nature.



06 ice / pad printing 40 x 9 mm  
tampografia 40 x 9 mm

Plastica riciclata  
Colori coprenti con finitura satinata,  
piccola sfera in colore coprente lucido

La bellezza  
della sostenibilità:  
8 sfumature  
di colore ispirate  
alla natura.



58 graphite / pad printing 40 x 9 mm  
tampografia 40 x 9 mm

# Zink

△ RECYCLED

Solid geometries.  
*Solide geometrie.*

A pen with a clean-cut  
profile and strong  
personality.

*Una penna dal profilo  
tagliante e dal carattere  
deciso.*



QUALITY NOT QUANTITY

The entire Maxema collection is available in recycled plastic on request /  
*Tutta la collezione Maxema è realizzabile in plastica riciclata su richiesta*

Technical information at p. 264  
*Informazioni tecniche a pag. 264*

Recycled plastic  
Solid colours barrel, solid white  
colour cap, glossy finishes

Elegance and  
environmental  
friendliness:  
uncompromisingly  
together.



10



76



87



19



21 abyss / pad printing 43 x 9 mm  
tampografia 43 x 9 mm



58



07

Plastica riciclata  
Fusto in colori coprenti, cappuccio in  
colore bianco coprente, finiture lucide

Eleganza e  
attenzione per  
l'ambiente: insieme  
senza compromessi.



06



10 cloud / pad printing 43 x 9 mm  
tampografia 43 x 9 mm



76



87

Recycled plastic  
Solid colours with glossy finish



**MY BOX RECYCLED**

Universal reclosable single pen box  
in recycled Fedrigoni paper.  
Info at p. 278

*Astuccio universale richiudibile per  
penna singola in cartoncino riciclato  
Fedrigoni.  
Info pag. 278*



19



21



58

07 onyx / pad printing 43 x 9 mm  
tampografia 43 x 9 mm



Plastica riciclata  
Colori coprenti con finitura lucida

# Pixel

△ RECYCLED

High resolution design.  
*Il design ad alta definizione.*

A synthesis  
of contemporary style.

*Sintesi dello stile  
contemporaneo.*



QUALITY NOT QUANTITY

The entire Maxema collection is available in recycled plastic on request /  
*Tutta la collezione Maxema è realizzabile in plastica riciclata su richiesta*

Technical information at p. 272  
*Informazioni tecniche a pag. 272*



PX40 | MATT CB RE

Recycled plastic  
Solid colour barrel with matt finish,  
solid glossy white colour clip  
and push-button



10



87

76 desert / pad printing 30 x 8 mm  
tampografia 30 x 8 mm



19



21

58 graphite / pad printing 30 x 8 mm  
tampografia 30 x 8 mm



07

Plastica riciclata  
Fusto in colore coprente con finitura  
satinata, clip e tappino in colore  
bianco coprente con finitura lucida



**MY BOX RECYCLED**

Universal reclosable single pen box  
in recycled Fedrigoni paper.  
Info at p. 278

*Astuccio universale richiudibile per  
penna singola in cartoncino riciclato  
Fedrigoni.  
Info pag. 278*

PX40 | MATT RE

06



10



76



87

Recycled plastic  
Solid colour barrel with matt finish,  
solid glossy colour clip and push-button

Guaranteed  
and certified  
recycled plastic  
of European origin.



21



58



07

19 forest / pad printing 30 x 8 mm  
tampografia 30 x 8 mm

*Plastica riciclata  
Fusto in colore coprente  
con finitura satinata, clip e tappino  
in colore coprente con finitura lucida*

Plastica riciclata  
di provenienza  
europea, garantita  
e certificata.

# Bay

△ RECYCLED

Casual and attractive.  
*Disinvolta e accattivante.*

Draws attention  
for its simplicity.

*Attrae per  
la sua semplicità.*

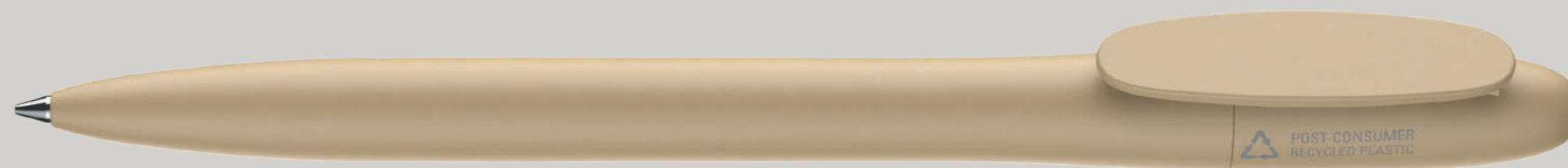

QUALITY NOT QUANTITY

The entire Maxema collection is available in recycled plastic on request /  
*Tutta la collezione Maxema è realizzabile in plastica riciclata su richiesta*

Technical information at p. 273  
*Informazioni tecniche a pag. 273*

Recycled plastic  
Solid colours with matt finish

Change is a  
choice and it  
depends on  
each of us.



06

10

76

87



19

21

07

58 graphite / pad printing 30 x 7 mm  
tampografia 30 x 7 mm

Plastica riciclata  
Colori coprenti con finitura satinata

Il cambiamento  
è una scelta  
e dipende  
da ognuno di noi.



**MY BOX RECYCLED**

Universal reclosable single pen box  
in recycled Fedrigoni paper.  
Info at p. 278

*Astuccio universale richiudibile per penna  
singola in cartoncino riciclato Fedrigoni.  
Info pag. 278*



The entire Maxema collection  
is available in recycled plastic  
on request.\*

—

*Tutta la collezione Maxema  
è realizzabile in plastica  
riciclata su richiesta.\**

\*On orders over 10,000 units. / Per ordini superiori alle 10.000 unità.

# Mood Metal

---

Design with a metal touch.  
*Il design incontra il metallo.*

---

Luxury is a state of mind.  
*Il lusso è un'attitudine.*



The entire Maxema collection is available in recycled plastic on request /  
*Tutta la collezione Maxema è realizzabile in plastica riciclata su richiesta*

Technical information at p. 258  
*Informazioni tecniche a pag. 258*

---

Chrome finish metal barrel, tip and push-button, solid colour clip with glossy finish

Metal details with diamond mirror finish.

Fusto, punta e tappino in metallo con finitura cromata, clip in colore coprente lucido

Finitura a specchio diamantata per i particolari in metallo.



01 70 03 18 15

74 burgundy / pad printing 40 x 9 mm  
74 bordeaux / tampografia 40 x 9 mm



60 61 71 25 72 73

### MY BOX

All Mood models come with a single My Box case in black Fedrigoni cardboard included.  
Info at p. 277

*Tutti i modelli Mood vengono forniti con astuccio singolo My Box in cartoncino nero Fedrigoni incluso.  
Info pag. 277*



75 dark green / pad printing 40 x 9 mm  
75 verde scuro / tampografia 40 x 9 mm



79 09



26 27 64 77 12 22 05 04

MD1 | M M4

Titanium grey finish metal barrel, tip and push-button, solid colour clip with glossy finish

New titanium grey finish: metal in a dynamic version.

Fusto, punta e tappino in metallo con finitura grigio titanio, clip in colore coprente lucido

Nuova finitura grigio titanio: il metallo in versione dinamica.



70 03 18 15 74 60 71 72



73 79 09 75 27 77 22 05

04 black / pad printing 40 x 9 mm  
04 nero / tampografia 40 x 9 mm



01 white / pad printing 40 x 9 mm  
01 bianco / tampografia 40 x 9 mm

### MY BOX

All Mood models come with a single My Box case in black Fedrigoni cardboard included.  
Info at p. 277

*Tutti i modelli Mood vengono forniti con astuccio singolo My Box in cartoncino nero Fedrigoni incluso.  
Info pag. 277*



MD1 | M M2

01 white / pad printing 40 x 9 mm  
01 bianco / tampografia 40 x 9 mm



Gold finish metal barrel, tip and push-button, solid colour clip with glossy finish

Metal with gold finish: pure light.

### MY BOX

All Mood Metal models come with a single My Box case in black Fedrigoni cardboard included. Info at p. 277

*Tutti i modelli Mood Metal vengono forniti con astuccio singolo My Box in cartoncino nero Fedrigoni incluso. Info pag. 277*

04 black / pad printing 40 x 9 mm  
04 nero / tampografia 40 x 9 mm



Fusto, punta e tappino in metallo con finitura dorata, clip in colore coprente lucido

Metallo con finitura oro: luce allo stato puro.

# Mood

---

Design with a metal touch.  
*Il design incontra il metallo.*

---

Luxury is a state of mind.  
*Il lusso è un'attitudine.*



The entire Maxema collection is available in recycled plastic on request /  
*Tutta la collezione Maxema è realizzabile in plastica riciclata su richiesta*

Technical information at p. 259  
*Informazioni tecniche a pag. 259*

---

Solid colours with glossy finish,  
chrome finish metal tip and push-button

**Fast Dry Gel**

Blue and black  
Fast Dry Gel ink  
refills available for  
all Mood versions.

Colori coprenti con finitura lucida,  
punta e tappino in metallo  
con finitura cromata

**Fast Dry Gel**

Refill gel Fast  
Dry blu e nero  
disponibili su  
richiesta per tutte  
le versioni Mood.

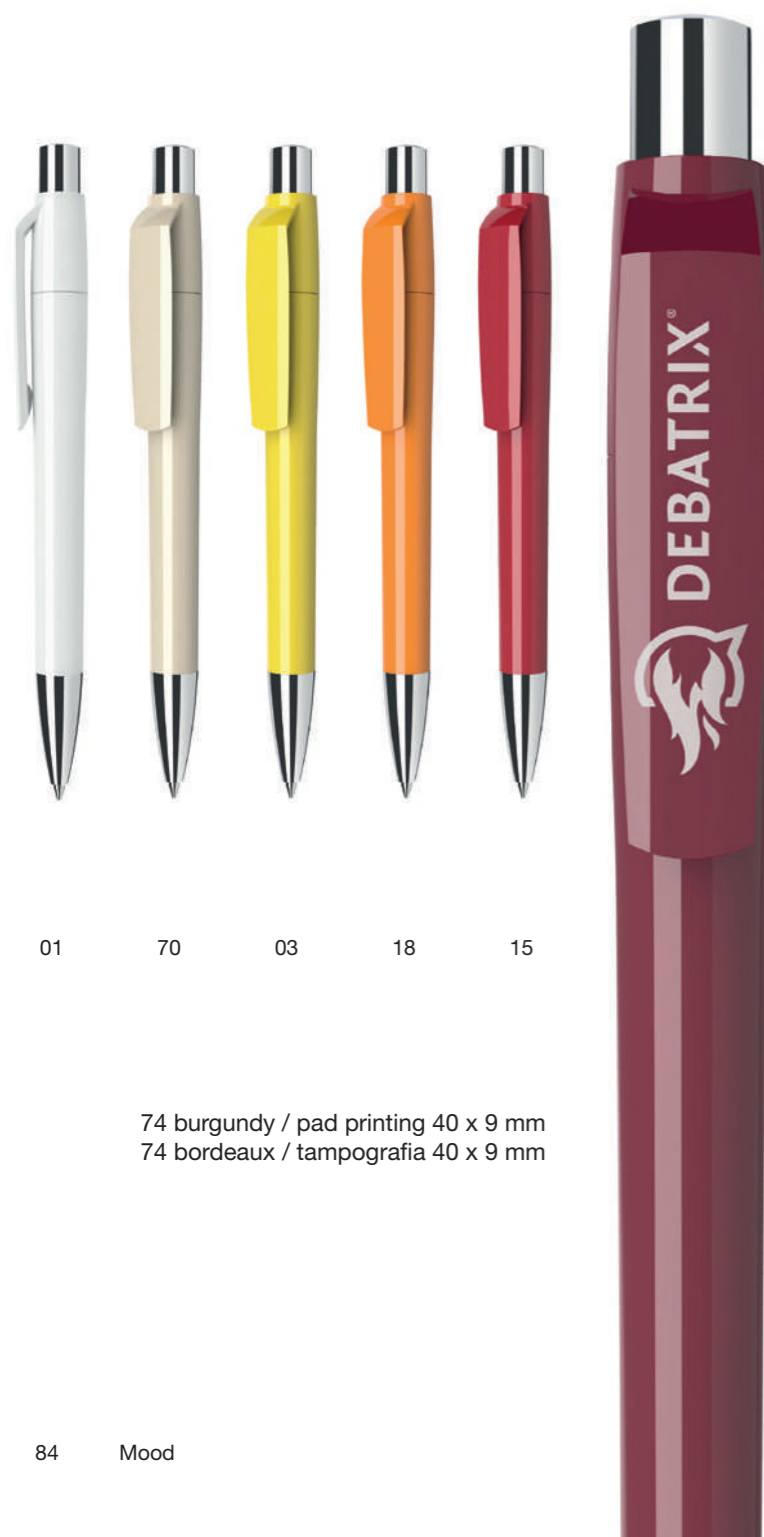

01 70 03 18 15

74 burgundy / pad printing 40 x 9 mm  
74 bordeaux / tampografia 40 x 9 mm



60 61 71 25 72

**MY BOX**

All Mood models come with a single  
My Box case in black Fedrigoni  
cardboard included.  
Info at p. 277

*Tutti i modelli Mood vengono forniti  
con astuccio singolo My Box in  
cartoncino nero Fedrigoni incluso.  
Info pag. 277*



73 79 09 75 26

27 octan green / pad printing 40 x 9 mm  
27 ottanio / tampografia 40 x 9 mm



64 77 12 22 05 04

MD1 | GOM CB M1

Solid colour barrel with rubber finish,  
solid glossy white colour clip,  
chrome finish metal tip and push-button

18 orange / pad printing 40 x 9 mm  
18 arancio / tampografia 40 x 9 mm



03



15

74



60 pink / pad printing 40 x 9 mm  
60 rosa / tampografia 40 x 9 mm



61

71

25

72

73



79

09



75 dark green / pad printing 40 x 9 mm  
75 verde scuro / tampografia 40 x 9 mm



26

27

64

77

12

22

05

04

Fusto in colore coprente gommato,  
clip in colore bianco lucido, punta  
e tappino in metallo con finitura  
cromata

**MY BOX**

All Mood models come with a single  
My Box case in black Fedrigoni  
cardboard included.  
Info at p. 277

*Tutti i modelli Mood vengono forniti  
con astuccio singolo My Box in  
cartoncino nero Fedrigoni incluso.  
Info pag. 277*

Solid colour barrel with rubber finish,  
solid colour clip with glossy finish,  
chrome finish metal tip and push-button

Result of  
superior quality  
craftsmanship.

*Fusto in colore coprente gommato,  
clip in colore coprente con finitura  
lucida, punta e tappino in metallo  
con finitura cromata*

Risultato  
di lavorazioni  
artigiane di  
qualità superiore.



70 03 18 15 74 60 61 71 25 72 73



79 09 75 26 27 64 77 12 22 05



04 black / pad printing 40 x 9 mm  
04 nero / tampografia 40 x 9 mm

### MY BOX

All Mood models come with a single  
My Box case in black Fedrigoni  
cardboard included.  
Info at p. 277

*Tutti i modelli Mood vengono forniti  
con astuccio singolo My Box in  
cartoncino nero Fedrigoni incluso.  
Info pag. 277*

Solid colour barrel with rubber finish, transparent colour clip with glossy finish, chrome finish metal tip and push-button

31 light violet / pad printing 40 x 9 mm  
31 viola chiaro / tampografia 40 x 9 mm

52 yellow / pad printing 40 x 9 mm  
52 giallo / tampografia 40 x 9 mm



39

53

45

59

41

55

37



38



49



47



34



67



44



30



50

78 lime / pad printing 40 x 9 mm  
78 lime / tampografia 40 x 9 mm

Fusto in colore coprente gommato, clip in colore trasparente con finitura lucida, punta e tappino in metallo con finitura cromata

### MY BOX

All Mood models come with a single My Box case in black Fedrigoni cardboard included.  
Info at p. 277

*Tutti i modelli Mood vengono forniti con astuccio singolo My Box in cartoncino nero Fedrigoni incluso. Info pag. 277*

MD1 | C M2



01

04 black / pad printing 40 x 9 mm  
04 nero / tampografia 40 x 9 mm



Solid colours with glossy finish, gold finish metal tip and push-button

*Colori coprenti con finitura lucida, punta e tappino in metallo con finitura dorata*



MD1 | C M3



01

04 black / pad printing 40 x 9 mm  
04 nero / tampografia 40 x 9 mm



Solid colours with glossy finish, rose gold metal tip and push button

*Colori coprenti con finitura lucida, punta e tappino in metallo con finitura oro rosa*

Rose gold, in line with the colour trends of the moment.

Oro rosa, in linea con i trend cromatici del momento.

#### MY BOX

All Mood Metal models come with a single My Box case in black Fedrigoni cardboard included. Info at p. 277

*Tutti i modelli Mood Metal vengono forniti con astuccio singolo My Box in cartoncino nero Fedrigoni incluso. Info pag. 277*

# Icon Pure

---

All over soft touch.  
*Soft touch integrale.*

---

All-round personality.  
*Personalità a tutto tondo.*



The entire Maxema collection is available in recycled plastic on request /  
*Tutta la collezione Maxema è realizzabile in plastica riciclata su richiesta*

Technical information at p. 260  
*Informazioni tecniche a pag. 260*

---



Solid colours with rubber finish

Full rubber coating on the entire pen: for printing recommendations, please refer to the technical data sheet on page 260.



01 03 15 74 60 61 71 25 72 73

18 orange / pad printing 35 x 7 mm  
18 arancio / tampografia 35 x 7 mm

Colori coprenti con finitura gommata

Gommatura integrale su tutta la penna: per i consigli di stampa consultare la scheda tecnica a pag. 260

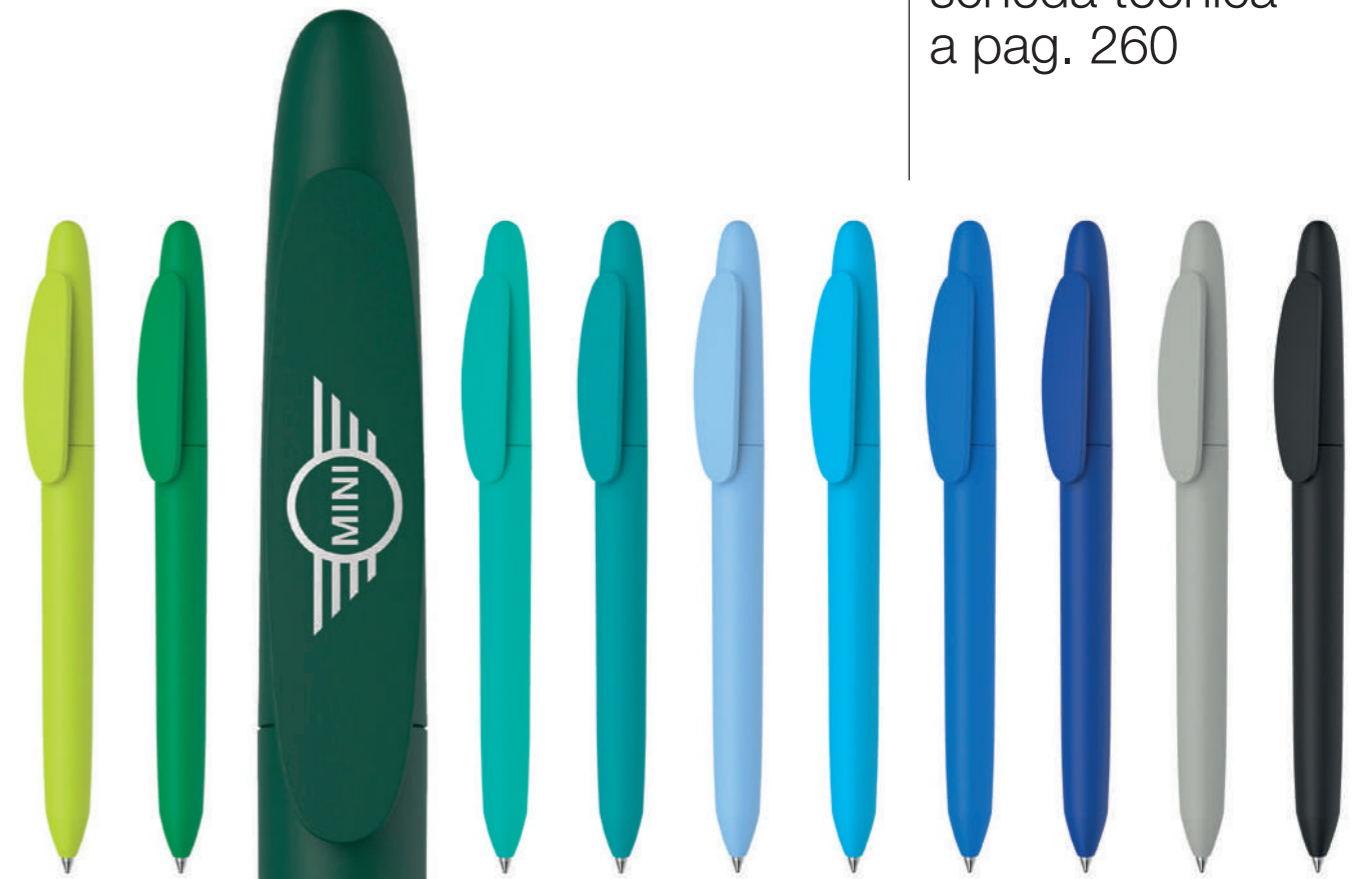

79 09 26 27 64 77 12 22 05 04

75 dark green / pad printing 35 x 7 mm  
75 verde scuro / tampografia 35 x 7 mm

# Flow Pure

---

Free from extra.  
*Pura ed essenziale.*

---

The essence of design.  
*L'essenza del design.*



The entire Maxema collection is available in recycled plastic on request /  
*Tutta la collezione Maxema è realizzabile in plastica riciclata su richiesta*

Technical information at p. 261  
*Informazioni tecniche a pag. 261*

---

Solid colour barrel and cap with rubber finish, solid colour clip with matt finish

Soft touch with matt finish is the new single-colour combination.

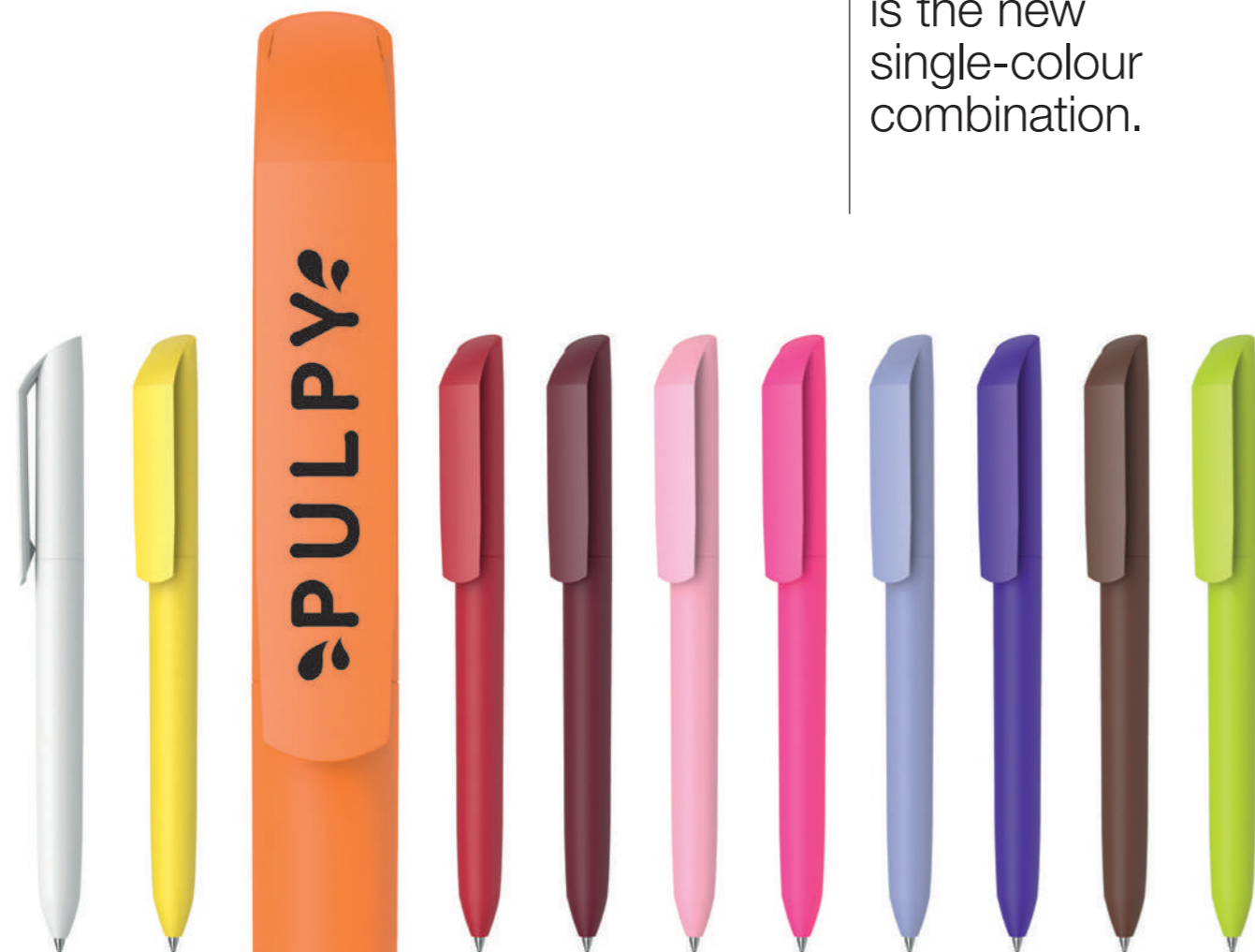

01

03

15

74

60

61

71

25

73

79

18 orange / pad printing 40 x 9 mm  
18 arancio / tampografia 40 x 9 mm

Fusto e cappuccio in colore coprente gommato, clip in colore coprente satinato

Soft touch con satinato è il nuovo abbinamento in versione monocromatica.



09

75

27

64

77

12

22

05

04

26 aquamarine / pad printing 40 x 9 mm  
26 acquamarina / tampografia 40 x 9 mm

F2P | MATT CB

Solid colour barrel and cap, solid white colour clip, matt finishes

Matt finish and white clip for maximum freedom of personalisation.



70 03 18 15 74 60 61 71 25 72 73 79

Fusto e cappuccio in colore coprente, clip in colore bianco coprente, finiture satinat

Finitura matt e clip bianca per la massima libertà di personalizzazione.



09 75 26 27 64 77 12 22 04

05 grey / pad printing 40 x 9 mm  
05 grigio / tampografia 40 x 9 mm

Solid colours with matt finish

All the expressive force of colour in a matt version.



01 70 03 18 15 74 60 61

25 72 73

71 light violet / pad printing 40 x 9 mm  
71 viola chiaro / tampografia 40 x 9 mm

Colori coprenti con finitura satinata

Tutta la forza espressiva del colore in versione satinata.



79 09 75 26 27 64 77 12

05 04

22 blue / pad printing 40 x 9 mm  
22 blu / tampografia 40 x 9 mm

Solid fluo colours with matt finish

The matt finish  
lights up with  
fluo colours.

FLUO



02



17 orange / pad printing 40 x 9 mm  
17 arancio / tampografia 40 x 9 mm



14

Colori fluo coprenti  
con finitura satinata

La finitura satinata  
si accende  
con i colori fluo.

FLUO



56 fucsia / pad printing 40 x 9 mm  
56 fucsia / tampografia 40 x 9 mm



08

Solid colours with glossy finish

The colours stand out due to the brilliance of the gloss finish.

Colori coprenti con finitura lucida

I colori risaltano grazie alla brillantezza della finitura lucida.



01 70 03 18 15 74



60 pink / pad printing 40 x 9 mm  
60 rosa / tampografia 40 x 9 mm



61 71 25 72



73 79 09 75 26 27 64 77 12 22 05 04

F2P | GOM K

Solid black barrel and cap with rubber finish, solid colour clip with glossy finish



70 cream / pad printing 40 x 9 mm  
70 crema / tampografia 40 x 9 mm



03



18 orange / pad printing 40 x 9 mm  
18 arancio / tampografia 40 x 9 mm



15



60



61



71



72



79



09



27



64



77



12



05



04

26 aquamarine / pad printing 40 x 9 mm  
26 acquamarina / tampografia 40 x 9 mm

Fusto e cappuccio in colore nero coprente gommato, clip in colore coprente lucido



F2P | GOM CB

Solid colour barrel and cap with rubber finish, solid white colour clip with glossy finish

Rubberised all over: soft touch barrel and cap.

60 pink / pad printing 40 x 9 mm  
60 rosa / tampografia 40 x 9 mm



01 03 18 15 74



61



25 73

71 light violet / pad printing 40 x 9 mm  
71 viola chiaro / tampografia 40 x 9 mm

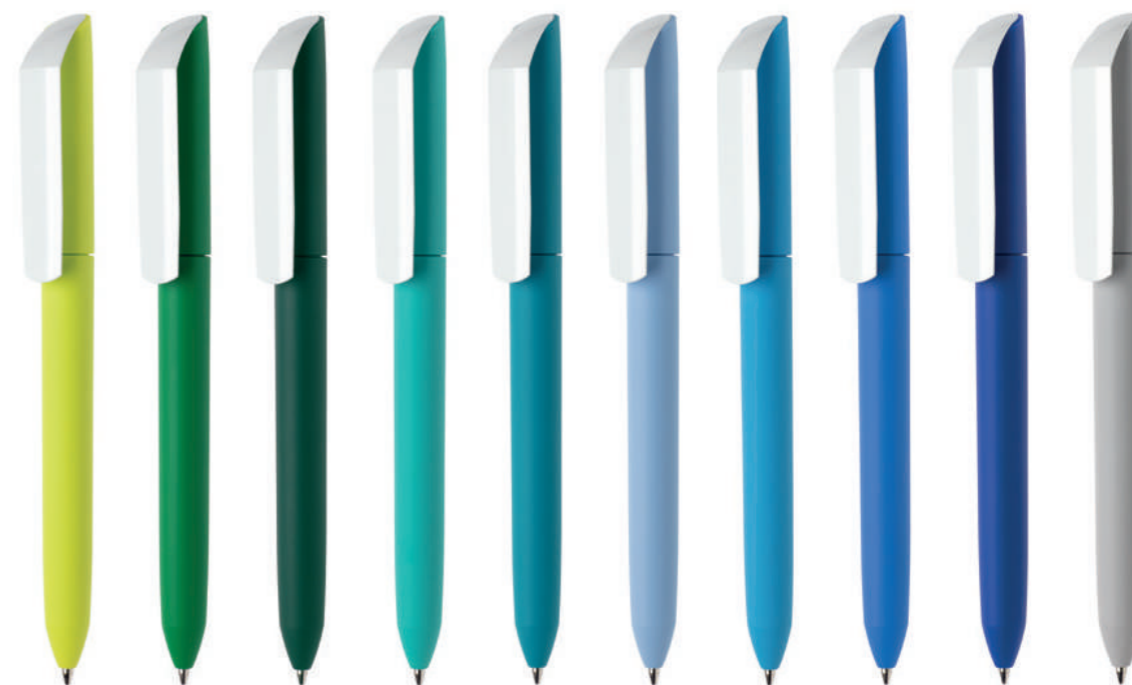

79 09 75 26 27 64 77 12 22 05

04 black / pad printing 40 x 9 mm  
04 nero / tampografia 40 x 9 mm

Fusto e cappuccio in colore coprente gommato, clip in colore bianco coprente lucido

Gommatura integrale: fusto e cappuccio soft touch.



Solid colour barrel and cap with rubber finish, transparent colour clip with glossy finish

Even the rubberised barrel can be pad or silk-screen printed.



39 52 53 45 59 41 31 55 37

38 brown / pad printing 40 x 9 mm  
38 marrone / tampografia 40 x 9 mm



78



49 green / pad printing 50 x 9 mm  
49 verde / tampografia 50 x 9 mm



47 34 67 44 30

50 dark grey / pad printing 40 x 9 mm  
50 grigio scuro / tampografia 40 x 9 mm

Fusto e cappuccio in colore coprente gommato, clip in colore trasparente lucido

Anche il fusto è stampabile con tampografia o serigrafia.



F2P | GOM CF

Solid fluo colour barrel and cap with rubber finish, solid fluo colour clip with glossy finish

*Fusto e cappuccio in colore fluo coprente gommato, clip in colore fluo coprente lucido.*

FLUO



02

17

14

56 fucsia / pad printing 40 x 9 mm  
56 fucsia / tampografia 40 x 9 mm



08

F2P | GOM KF

Solid black colour barrel and cap with rubber finish, solid fluo colour clip with glossy finish

*Fusto e cappuccio in colore nero coprente gommato, clip in colore fluo coprente lucido.*

FLUO



02 yellow / pad printing 40 x 9 mm  
02 giallo / tampografia 40 x 9 mm



17



56



08

14 coral red / pad printing 40 x 9 mm  
14 rosso corallo / tampografia 40 x 9 mm

Solid fluo colour barrel and cap with rubber finish, transparent fluo colour clip with glossy finish.

Minimal profile and compact volumes.

FLUO



**MY BOX**

Universal reclosable single pen box in Fedrigoni black card. Info at p. 277

*Astuccio universale richiudibile per penna singola in cartoncino nero Fedrigoni. Info pag. 277*



20



33 orange / pad printing 40 x 9 mm  
33 arancio / tampografia 40 x 9 mm



24



46

48 green / pad printing 40 x 9 mm  
48 verde / tampografia 40 x 9 mm



Fusto e cappuccio in colore fluo coprente gommato, clip in colore fluo trasparente lucido.

Profilo minimal e volumi compatti.

FLUO

# Flow

---

Feel the change.  
*Senti il cambiamento.*

---

Evolution of shape,  
with and without texturing.

*L'evoluzione della forma,  
con e senza texture.*



The entire Maxema collection is available in recycled plastic on request /  
*Tutta la collezione Maxema è realizzabile in plastica riciclata su richiesta*

Technical information at p. 262  
*Informazioni tecniche a pag. 262*

---

F1 MATT AL

Solid colours with matt finish,  
aluminium painted finish tip

Matt colours  
and aluminium  
colour tip: satin  
style elegance.



01 70 03 18 15 74 60 61 71 25 73

Colori coprenti con finitura  
satinata, punta verniciata  
in colore alluminio

Colori matt  
e punta color  
alluminio:  
eleganza in  
versione satinata.

79 lime / pad printing 40 x 9 mm  
79 lime / tampografia 40 x 9 mm



09 75 26 27 64

77 cyan / pad printing 40 x 9 mm  
77 ciano / tampografia 40 x 9 mm



12 22 05 04

Solid colours with glossy finish,  
chromed tip

Colori coprenti con finitura lucida,  
punta cromata



70 03 18 15 74 60 61 71 25 73

01 white / pad printing 40 x 9 mm  
01 bianco / tampografia 40 x 9 mm

77 cyan / pad printing 40 x 9 mm  
77 ciano / tampografia 40 x 9 mm



79 09 75 26 27 64

77 cyan / pad printing 46 x 9 mm  
77 ciano / tampografia 46 x 9 mm



12 22 05 04

F1T | GOM C CR

Solid colour barrel with rubber finish, solid colour clip with glossy finish, textured solid colour cap with matt finish, chromed tip

Distinctive feature: textured cap.

*Fusto in colore coprente gommato, clip in colore coprente lucido, cappuccio texturizzato in colore coprente con finitura satinata, punta cromata*

Elemento distintivo: cappuccio arricchito da una texture.



01 70 03



15 74 60 61 71 25 73

18 orange / pad printing 40 x 9 mm  
18 arancio / tampografia 40 x 9 mm



79 09 75 26 27 64 77 12 22 05

04 black / pad printing 40 x 9 mm  
04 nero / tampografia 40 x 9 mm





Solid colour barrel with rubber finish, solid glossy white colour clip, textured solid colour cap with matt finish, chromed tip

Textured with small hexagonal cells that recall a honeycomb: a dynamic design of visual and tactile elegance.



03 18 15 74 60 61 71 25

73 brown / pad printing 40 x 9 mm  
73 marrone / tampografia 40 x 9 mm



79



09 75 27 64 77 12 22 04

26 aquamarine / pad printing 40 x 9 mm  
26 acquamarina / tampografia 40 x 9 mm



05 grey / pad printing 40 x 9 mm  
05 grigio / tampografia 40 x 9 mm

Fusto in colore coprente gommato, clip in colore bianco lucido, cappuccio texturizzato in colore coprente con finitura satinata, punta cromata

Texture costituita da piccole celle esagonali che ricordano un nido d'ape: un design dinamico che dona eleganza visiva e tattile.

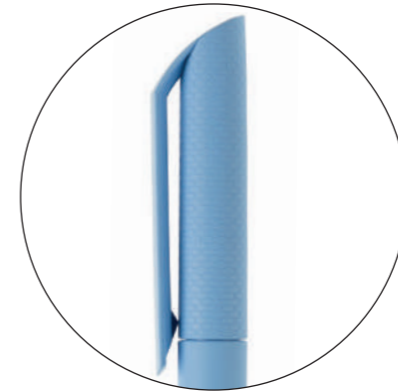

F1T | GOM 30 CR

Solid colour barrel with rubber finish, transparent glossy colour clip, textured solid colour cap with matt finish, chromed tip



59 pink / pad printing 40 x 9 mm  
59 rosa / tampografia 40 x 9 mm

Fusto in colore coprente gommato, clip in colore trasparente lucido, cappuccio texturizzato in colore coprente con finitura satinata, punta cromata

30 light grey / pad printing 40 x 9 mm  
30 grigio chiaro / tampografia 40 x 9 mm



34 pastel blue / pad printing 40 x 9 mm  
34 azzurro pastello / tampografia 40 x 9 mm

# Dot

---

Different from the rest, full stop.  
*Diversa da tutte, punto.*

---

A pen that reveals  
its originality in its details.

*È nei dettagli che rivela  
la sua originalità.*



The entire Maxema collection is available in recycled plastic on request /  
*Tutta la collezione Maxema è realizzabile in plastica riciclata su richiesta*

Technical information at p. 263  
*Informazioni tecniche a pag. 263*

---

Solid white colour barrel, clip and push-button with matt finish, solid glossy colour little sphere

The matt finish enhances the design and offers new tactile sensations.

The touch of colour stands out against the pure white.



01

03 yellow / pad printing 40 x 9 mm  
03 giallo / tampografia 40 x 9 mm

Fusto, clip e tappino in colore bianco coprente con finitura satinata, piccola sfera in colore coprente lucido

La finitura satinata esalta il design e offre nuove sensazioni tattili.

Il punto di colore spicca nella nitidezza del bianco.



D1 MATT CB

Solid colour barrel with matt finish,  
solid matt white clip and push-  
button, solid glossy colour  
little sphere



03 18 15 74

60 pink / pad printing 40 x 9 mm  
60 rosa / tampografia 40 x 9 mm

Fusto in colore coprente con finitura  
satinata, clip e tappino in colore  
bianco coprente satinato, piccola  
sfera in colore coprente lucido



79 09 75 26 27 64 77

12 light blue / pad printing 40 x 9 mm  
12 azzurro / tampografia 40 x 9 mm

22 05 04

D1 MATT

Solid colours with matt finish, solid glossy colour little sphere

Attractive and refined: the integral matt finish.



70 03 18 15 74 60 61

71 light violet / pad printing 40 x 9 mm  
71 viola chiaro / tampografia 40 x 9 mm



25 72 73



79 09 75 26 27 64 77 12 22 05

04 black / pad printing 40 x 9 mm  
04 nero / tampografia 40 x 9 mm

Solid black colour barrel, clip and push-button with matt finish, solid glossy colour little sphere

Purity of lines and matt finish: simply elegant.



01

70 cream / pad printing 40 x 9 mm  
70 crema / tampografia 40 x 9 mm

Minimal black is combined with a discreet touch of colour.

Fusto, clip e tappino in colore nero coprente con finitura satinata, piccola sfera in colore coprente lucido

Purezza di linee e finitura matt: semplicemente elegante.



Il nero minimal è abbinato a una piccola e discreta nota di colore.

Solid fluo colours with matt finish,  
solid glossy fluo colour little sphere

A more profound  
chromatic impact  
thanks to the fluo  
colours.

FLUO



02



17



56



08

14 coral red / pad printing 40 x 9 mm  
14 rosso corallo / tampografia 40 x 9 mm

Colori fluo coprenti con finitura  
satinata, piccola sfera in colore fluo  
coprente lucido

Impatto cromatico  
più incisivo  
grazie ai colori  
fluo.

FLUO



Solid white colour barrel and clip with glossy finish, solid glossy colour little sphere, chromed push-button

A white surface is the creative foundation par excellence: freedom of expression and top colour rendering.

Total white: basic and elegant thanks to its refined colour detail.



01

03 yellow / pad printing 40 x 9 mm  
03 giallo / tampografia 40 x 9 mm



Fusto e clip in colore bianco coprente con finitura lucida, piccola sfera in colore coprente lucido, tappino cromato

La superficie bianca è la base creativa per eccellenza: libertà di espressione e massima resa cromatica.

Total white: essenziale ed elegante grazie al raffinato dettaglio di colore.

D1 CB CR

Solid colour barrel and little sphere with glossy finish, solid glossy white colour clip, chromed push-button

Fusto e piccola sfera coprente lucido, clip in colore bianco coprente lucido, tappino cromato



03

18

74

60

61

71

25

73

79

09

75

27

64

77

12

22

05

15 red / pad printing 40 x 9 mm  
15 rosso / tampografia 40 x 9 mm

04 black /  
pad printing  
40 x 9 mm  
04 nero /  
tampografia  
40 x 9 mm

D1 C CR

Solid colours with glossy finish,  
chromed push-button

Colori coprenti con finitura lucida,  
tappino cromato

74 burgundy / pad printing 40 x 9 mm  
74 bordeaux / tampografia 40 x 9 mm

64 pastel blue / pad printing 40 x 9 mm  
64 azzurro pastello / tampografia 40 x 9 mm



70

03

15

60

61

71

25

73

79

09

75

27

77

12

22

05

18 orange /  
pad printing  
40 x 9 mm  
18 arancio /  
tampografia  
40 x 9 mm

04 black /  
pad printing  
40 x 9 mm  
04 nero /  
tampografia  
40 x 9 mm

D1 30 CR

Transparent colours with glossy finish, solid glossy colour little sphere, chromed push-button

Colori trasparenti con finitura lucida, piccola sfera in colore coprente lucido, tappino cromato



39



52 yellow / pad printing 40 x 9 mm  
52 giallo / tampografia 40 x 9 mm



53

45

41

55

37

38



78 lime /  
pad printing  
40 x 9 mm  
78 lime /  
tampografia  
40 x 9 mm



49

47

67

44

50

Solid black colour barrel with rubber finish, solid black colour clip and push-button with glossy finish, solid glossy colour little sphere

The elegance of black combines with a soft touch finish for a high-impact result.



01

70 cream / pad printing 40 x 9 mm  
70 crema / tampografia 40 x 9 mm



Total black with a note of colour.



03



18



15



74



60



61



71



25



72



73



79



09



75



26



27



77



12



22



05



04

Fusto in colore nero coprente gommato, clip e tappino in colore nero coprente lucido, piccola sfera in colore coprente lucido

L'eleganza del nero si combina con la finitura soft touch per un risultato di grande impatto.

Total black con nota di colore.

Solid colour barrel with rubber finish, solid glossy white colour clip, solid glossy colour little sphere, chromed push-button



01 03

15 74 60 61 71

73

18 orange /  
pad printing  
40 x 9 mm  
18 arancio /  
tampografia  
40 x 9 mm

25 dark violet /  
pad printing  
40 x 9 mm  
25 viola scuro /  
tampografia  
40 x 9 mm

64 pastel blue / pad printing 40 x 9 mm  
64 azzurro pastello / tampografia 40 x 9 mm



79 09 75 26 27

77 12 22

04

05 grey /  
pad printing  
40 x 9 mm  
05 grigio /  
tampografia  
40 x 9 mm

*Fusto in colore coprente gommato, clip in colore bianco coprente lucido, piccola sfera in colore coprente lucido, tappino cromato*

D1 | GOM C CR

Solid colour barrel with rubber finish, solid colour clip and little sphere with glossy finish, chromed push-button

Fusto in colore coprente gommato, clip e piccola sfera in colore coprente con finitura lucida, tappino cromato



71 light violet / pad printing 40 x 9 mm  
71 viola chiaro / tampografia 40 x 9 mm



18 15 74 60 61

03 yellow / pad printing 40 x 9 mm  
03 giallo / tampografia 40 x 9 mm



25 72 73



79 09 75 27 64 77 12

22 blue / pad printing 40 x 9 mm  
22 blu / tampografia 40 x 9 mm



05 04

D1 | GOM 30 CR

Solid colour barrel with rubber finish, transparent colour clip with glossy finish, solid glossy colour little sphere, chromed push-button



39 52 53 45 59 41 31 55 37

38 brown / pad printing 40 x 9 mm  
38 marrone / tampografia 40 x 9 mm

*Fusto in colore coprente gommato, clip in colore trasparente con finitura lucida, piccola sfera in colore coprente lucido, tappino cromato*



78 49 47 34 67 44 30

50 dark grey / pad printing 40 x 9 mm  
50 grigio scuro / tampografia 40 x 9 mm



D1 | C GOLD

Solid colours with glossy finish,  
gilded push-button

*Colori coprenti con finitura lucida,  
tappino dorato*



01 white / pad printing 40 x 9 mm  
01 bianco / tampografia 40 x 9 mm



04

D1 | GOM KF CR

Solid black colour barrel with rubber  
finish, solid fluo colour clip  
and little sphere with glossy finish,  
chromed push-button

*Fusto in colore nero coprente  
gommato, clip e piccola sfera  
in colore fluo coprente lucido,  
tappino cromato*



02

17 orange /  
pad printing  
40 x 9 mm  
17 arancio /  
tampografia  
40 x 9 mm



56



08

14 coral red / pad printing 40 x 9 mm  
14 rosso corallo / tampografia 40 x 9 mm

# Zink

---

Solid geometries.  
*Solide geometrie.*

---

A pen with a  
clean-cut profile  
and strong personality.

*Una penna  
dal profilo tagliente  
e dal carattere deciso.*



The entire Maxema collection is available in recycled plastic on request /  
*Tutta la collezione Maxema è realizzabile in plastica riciclata su richiesta*

Technical information at p. 264  
*Informazioni tecniche a pag. 264*

---

Solid colours barrel, solid white colour cap, glossy finishes

More suitability for multi-colour printing with white clip.

*Fusto in colori coprenti, cappuccio in colore bianco coprente, finiture lucide*

Maggiore versatilità per la stampa a più colori con la clip bianca.



70 03 18 15 74



61 71 25 73

60 pink / pad printing 43 x 9 mm  
60 rosa / tampografia 43 x 9 mm

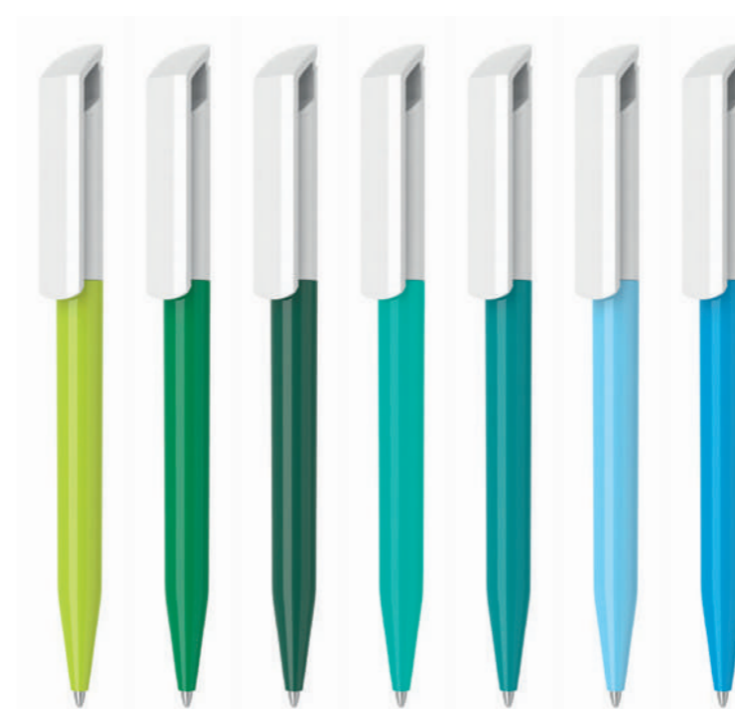

79 09 75 26 27 64 77

12 light blue / pad printing 43 x 9 mm  
12 azzurro / tampografia 43 x 9 mm



22 05 04

Solid colours with glossy finish

Solid, sturdy architecture for a profile of geometric precision.

Colori coprenti con finitura lucida

Architettura corposa e robusta per un profilo dal rigore geometrico.



01 70 03



18 orange / pad printing 43 x 9 mm  
18 arancio / tampografia 43 x 9 mm



15 74 60 61 25 73



79 09 75



64 77 12 22

05 grey / pad printing 43 x 9 mm  
05 grigio / tampografia 43 x 9 mm

27 octan green / pad printing 43 x 9 mm  
27 ottanio / tampografia 43 x 9 mm



04

Transparent colours with glossy finish

Its sturdy structure is offset by the slim, streamlined barrel.



39 52 53 45 59 41 51 31 55

37 amber / pad printing 43 x 9 mm  
37 ambra / tampografia 43 x 9 mm



Colori trasparenti con finitura lucida

Il fusto slanciato bilancia la solida struttura.

67 cyan / pad printing 43 x 9 mm  
67 ciano / tampografia 43 x 9 mm



38 78 49 47



44 30 50

Solid fluo colours with glossy finish

Fluo colours,  
intense and  
vibrant shades.

FLUO



02



17 orange / pad printing 43 x 9 mm  
17 arancio / tampografia 43 x 9 mm



14

56

Colori fluo coprenti  
con finitura lucida

Colori fluo,  
tonalità intense  
e vibranti.

FLUO



08 green / pad printing 43 x 9 mm  
08 verde / tampografia 43 x 9 mm

# View

---

Decisive personality.  
*Carattere incisivo.*

---

Exudes boldness from every angle and captivates with its elegance.

*Sprigiona grinta da ogni punto di vista e affascina per l'eleganza.*

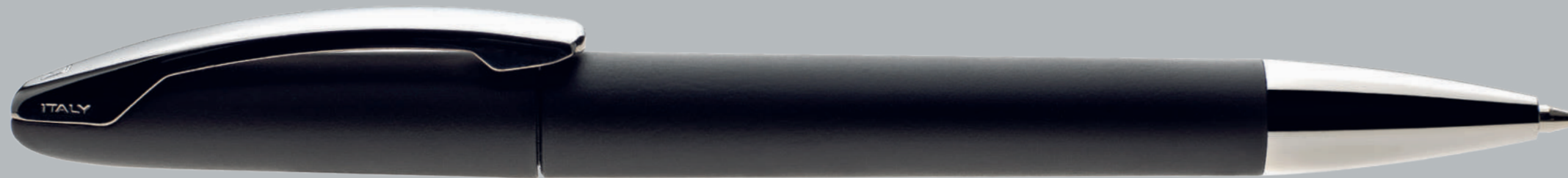

The entire Maxema collection is available in recycled plastic on request /  
*Tutta la collezione Maxema è realizzabile in plastica riciclata su richiesta*

Technical information at p. 265  
*Informazioni tecniche a pag. 265*

---

V1 C CR / C CRT

V1 - C CR clip per incisione laser / clip for laser engraving

V1 - C CRT clip per tampografia / clip for pad printing

Solid colours with glossy finish, metal chrome finish clip, chromed tip

Colori coprenti con finitura lucida, clip in metallo cromato, punta cromata



01 70 03 18 15 74

60 pink / laser engraving 30 x 7 mm  
60 rosa / incisione laser 30 x 7 mm



61 71



25 73



79 lime / screen printing 42 x 30 mm  
79 lime / serigrafia 42 x 30 mm



09 75 27 64 12

22 blue / pad printing on the clip 40 x 6 mm  
22 blu / tampografia su clip 40 x 6 mm



04



V1 | 30 CR / 30 CR T

V1 – 30 CR clip per incisione laser / clip for laser engraving

V1 – 30 CR T clip per tampografia / clip for pad printing

Transparent colours with glossy finish, metal chrome finish clip, chromed tip

Colori trasparenti con finitura lucida, clip in metallo cromato, punta cromata



52 53 45 51 55 49 47 44 40

39 neutral / screen printing 42 x 30 mm  
39 neutro / serigrafia 42 x 30 mm

V1 | AL CR / AL CR T

V1 – AL CR clip per incisione laser / clip for laser engraving

V1 – AL CR T clip per tampografia / clip for pad printing

Aluminium painted finish barrel and cap, metal chromed clip, chromed tip

Fusto e cappuccio verniciati in colore alluminio, clip in metallo cromato, punta cromata



The sleek design of the cap adds elegance and balances the large clip.

La linea affilata del cappuccio dà armonia e bilancia l'imponenza della clip.

aluminium / laser engraving 30 x 7 mm  
alluminio / incisione laser 30 x 7 mm

V1 GOM C CR / GOM C CR T

**V1 - GOM C CR**  
clip per incisione laser /  
clip for laser engraving

**V1 - GOM C CR T**  
clip per tampografia /  
clip for pad printing

Solid colour barrel and cap with  
rubber finish, metal chrome clip,  
chromed tip

Free rein to  
colours on  
metals too.

Fusto e cappuccio in colore coprente  
gommato, clip in metallo cromato,  
punta cromata

Via libera ai colori,  
anche su metallo.



03

15

74

60

18 orange /  
pad printing on the clip 40 x 6 mm  
18 arancio /  
tampografia su clip 40 x 6 mm

CLARINS

71

25

72

61 magenta /  
screen printing 42 x 30 mm  
61 magenta /  
serigrafia 42 x 30 mm

73

79

09

75

27

64 pastel blue / laser engraving 30 x 7 mm  
64 azzurro pastello / incisione laser 30 x 7 mm

AIRTOTAL

12

22

04 black / pad printing  
on the clip 40 x 6 mm  
04 nero / tampografia  
su clip 40 x 6 mm

General  
Construction  
Company  
ZH

# Tag

---

Imposing elegance.  
*Eleganza imponente.*

---

Clean-cut, refined  
design, a tribute  
to perfect elegance.

*Design semplice  
e raffinato, omaggio  
all'eleganza perfetta.*



The entire Maxema collection is available in recycled plastic on request /  
*Tutta la collezione Maxema è realizzabile in plastica riciclata su richiesta*

Technical information at p. 266  
*Informazioni tecniche a pag. 266*

---

TA1 | MATT AL B

Solid white colour barrel and clip with matt finish, solid colour upper plug with glossy finish, aluminium painted finish tip

*Fusto e clip in colore bianco coprente con finitura satinata, tassello superiore in colori coprenti con finitura lucida, punta verniciata in colore alluminio*



01 white / pad printing 40 x 9 mm  
 01 bianco / tampografia 40 x 9 mm  
 —  
 screen printing 42 x 30 mm  
 serigrafia 42 x 30 mm



03      18      15      74

61 magenta / pad printing 40 x 9 mm  
 61 magenta / tampografia 40 x 9 mm



71      25



72      73      79      09      27

64 pastel blue / pad printing 40 x 9 mm  
 64 azzurro pastello / tampografia 40 x 9 mm



12      22      04

Solid white colour barrel and clip,  
solid colour upper plug, glossy  
finishes, chromed tip

Elegance and  
linearity to express  
all the strength  
of a brand.

15 red / pad printing 40 x 9 mm  
15 rosso / tampografia 40 x 9 mm



03

18

74

61

09

27

12

22

*Fusto e clip in colore bianco, tassello  
superiore in colori coprenti, finiture  
lucide, punta cromata*

Eleganza e  
linearità per  
esprimere tutta la  
forza di un brand.



04 black / pad printing 40 x 9 mm  
04 nero / tampografia 40 x 9 mm

Solid colours with glossy finish,  
chromed upper plug and tip

01 white / pad printing 40 x 9 mm  
01 bianco / tampografia 40 x 9 mm



70    03    18    15    74    60    61    71    25    72

64 pastel blue / pad printing 40 x 9 mm  
64 azzurro pastello / tampografia 40 x 9 mm



79    09    75    27

73 brown / pad printing 40 x 9 mm  
73 marrone / tampografia 40 x 9 mm

Colori coprenti con finitura lucida,  
tassello superiore e punta cromati



12    22    04

TA1 | MET AL

Metallic colours painted finish barrel and clip, aluminium painted finish upper plug and tip

*Fusto e clip verniciati in colori metallizzati, tassello superiore e punta verniciati in colore alluminio*



92

83



94

95

96



**MY BOX**

Universal reclosable single pen box in Fedrigoni black card.  
Info at p. 277

*Astuccio universale richiudibile per penna singola in cartoncino nero Fedrigoni. Info pag. 277*

85 red / pad printing 40 x 9 mm  
85 rosso / tampografia 40 x 9 mm

TA1 | AL CR

Aluminium painted finish barrel and clip, chromium upper plug and tip

*Fusto e clip verniciati in colore alluminio, tassello superiore e punta cromati*

Its rigorous styling is softened by the smooth curve of the clip and closing plug.

Lo stile rigoroso è ingentilito dalla dolce curvatura della clip e del suo tassello di chiusura.



aluminium / pad printing 40 x 9 mm  
alluminio / tampografia 40 x 9 mm

# Icon

---

Timeless design.  
*Design senza tempo.*

---

A perfect synthesis of  
past, present and future.

*L'incontro tra passato,  
presente e futuro.*



The entire Maxema collection is available in recycled plastic on request /  
*Tutta la collezione Maxema è realizzabile in plastica riciclata su richiesta*

Technical information at p. 267  
*Informazioni tecniche a pag. 267*

---



IC400 | MATT

Solid colours with matt finish

*Colori coprenti con finitura satinata*

Essential,  
harmonious  
design for a style  
that is never banal  
and always  
up-to-date.



01 70 03 18 15 60

79 lime / pad printing 35 x 7 mm  
79 lime / tampografia 35 x 7 mm



64 22 04

IC400 | FROST

Transparent colours with matt finish

*Colori trasparenti con finitura satinata*

Design dal profilo  
essenziale e  
armonico per uno  
stile mai scontato  
e sempre attuale.



39 52 53 45

51 violet / screen printing 40 x 30 mm  
51 viola / serigrafia 40 x 30 mm



55 49 47

44 blue /  
pad printing  
35 x 7 mm  
44 blu /  
tampografia  
35 x 7 mm



40

IC400 | MATT AL

Solid colours with matt finish,  
aluminium painted finish tip

Colori coprenti con finitura satinata,  
punta verniciata in colore alluminio



01 70 03

18 orange /  
pad printing 35 x 7 mm  
18 arancio /  
tampografia 35 x 7 mm



15 74 60 61

71 light violet /  
pad printing 35 x 7 mm  
71 viola chiaro /  
tampografia 35 x 7 mm



25



72 73 79 09 75

27 octan green / pad printing 35 x 7 mm  
27 ottanio / tampografia 35 x 7 mm



64 12 22

04 black /  
screen printing 40 x 30 mm  
04 nero /  
serigrafia 40 x 30 mm



Solid colours with glossy finish,  
chromed tip

Colori coprenti con finitura lucida,  
punta cromata



01 white / pad printing 45 x 9 mm  
01 bianco / tampografia 45 x 9 mm



70      03      18      15      74      60

61 magenta / pad printing 35 x 7 mm  
61 magenta / tampografia 35 x 7 mm



71      25



72



73 brown / pad printing 35 x 7 mm  
73 marrone / tampografia 35 x 7 mm



79      09



27      64      12      22      04

75 dark green / pad printing 35 x 7 mm  
75 verde scuro / tampografia 35 x 7 mm

IC400 | FROST AL

Transparent colours, matt finish,  
aluminium painted finish tip

*Colori trasparenti con finitura  
satinata, punta verniciata in colore  
alluminio*

53 orange / pad printing 35 x 7 mm  
53 arancio / tampografia 35 x 7 mm  
—  
screen printing 40 x 30 mm  
serigrafia 40 x 30 mm



39

52

45

51

55

49

47

44

40 grey / pad printing 35 x 7 mm  
40 grigio / tampografia 35 x 7 mm

IC400 | 30 CR

Transparent colours with  
glossy finish, chromed tip

*Colori trasparenti con finitura  
lucida, punta cromata*



39

52

53

51

55

49

44

40

45 red /  
pad printing 35 x 7 mm  
45 rosso /  
tampografia 35 x 7 mm

47 aquamarine /  
pad printing 35 x 7 mm  
47 acquamarina /  
tampografia 35 x 7 mm

IC400 | C GOLD

04 black / screen printing 40 x 30 mm  
04 nero / serigrafia 40 x 30 mm



01

74

75

22



Solid colours with glossy finish,  
gilded tip

*Colori coprenti con finitura lucida,  
punta dorata*



**MY CASE**

Universal single pen box in Fedrigoni  
black card.  
Info at p. 276

Astuccio universale per penna  
singola in cartoncino nero Fedrigoni.  
Info pag. 276

IC400 | MET AL

Metallic colours  
painted finish barrel  
and cap, aluminium  
painted finish tip

*Fusto e cappuccio  
verniciati in colori  
metallizzati, punta  
verniciata in colore  
alluminio*

Exclusive  
high strength  
metallic colours.



92

83 copper /  
pad printing  
35 x 7 mm  
83 rame /  
tampografia  
35 x 7 mm



85



94



95



96

Esclusivi colori  
metallizzati ad  
alta resistenza.

IC400 | AL CR

Aluminium painted  
finish barrel and  
cap, chromed tip

*Fusto e cappuccio  
verniciati in colore  
alluminio,  
punta cromata*



aluminium /  
pad printing  
35 x 7 mm  
alluminio /  
tampografia  
35 x 7 mm

# Tag green

---

Objective: total safety.  
*Obiettivo: sicurezza totale.*

---

Design that combines  
safety and environment  
friendliness.

*Il design sposa  
la sicurezza e rispetta  
l'ambiente.*

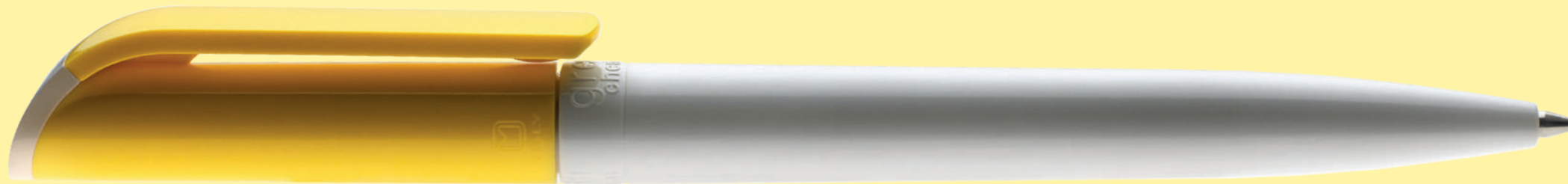

Technical information at p. 268  
*Informazioni tecniche a pag. 268*

---

# Made from a special plastic, suitable for use in toy manufacture.

Realizzata con plastica idonea alla produzione dei giocattoli.



## Looking to the future Guarda al futuro

Made of plastic suitable for toy manufacture (according to European standard EN 71-03 and U.S. FDA regulations).

*Prodotta con plastica idonea all'utilizzo nei giocattoli (direttiva europea EN 71 - 03 e direttiva americana FDA).*



## Antibacterial Antibatterica

It is made of antibacterial plastic containing a special additive which releases silver ions that prevent bacteria from colonising the surface of the pen.

*La plastica è antibatterica, grazie ad uno speciale additivo che sprigiona ioni d'argento impedendo ai batteri di depositarsi sulle superfici della penna.*



## Really safe Buona davvero

The plastics employed are compliant with European and American FDA food contact regulations.

*Le plastiche utilizzate sono conformi alla normativa europea e americana FDA per il contatto alimentare.*



## Nature friendly Vicina all'ambiente

Made of non-toxic plastics, it has been designed to have a long life and to minimise the risk of harmful substances being released into the environment. Using a pen for as long as possible helps to reduce pollution and enables us to give full expression to the concept of promotion.

*Realizzata con materiali atossici, è stata progettata per durare a lungo nel tempo. Una penna che dura di più inquina di meno perchè rimane a lungo nelle nostre mani, massimizzando la diffusione del logo o del messaggio che porta con sé.*



## Green Chemical

It does not contain dioxin, phthalates, bisphenol A, antimony, arsenic, barium, cadmium, chrome, mercury, lead, polybrominated biphenyls (PBBs), polybrominated diphenyl ethers (PBDEs) or deca-BDE, and conforms to RoHS and REACH directives.

*Non contiene: diossina, ftalati, bisfenolo A, antimonio, arsenico, bario, cadmio, cromo, mercurio, piombo, ed è conforme alle normative RoHS e REACH. Bifenili polibromurati (PBB), eteri di difenile (PBDE) e deca BDE sono completamente assenti, ed è conforme alle normative RoHS e REACH.*



## CLP compliant Conforme alle regole

It is rated as non hazardous pursuant to the Regulation on Classification, Labelling and Packaging.

*La plastica non risulta pericolosa per il CLP (classification, labeling and packaging).*



TA2 | B

Solid white colour barrel and clip,  
solid colours upper plug,  
glossy finishes

*Fusto e clip in colore bianco  
coprente, tassello superiore in colori  
coprenti, finiture lucide*

Green Chemical  
plastic releases  
silver ions that  
have an anti-  
bacterial function.



42 43 35 13 29 65 77 54 04

01 white / pad printing 40 x 9 mm  
01 bianco / tampografia 40 x 9 mm

TA2 | BC

Solid white colour barrel and upper  
plug, solid colours clip,  
glossy finishes

*Fusto e tassello superiore in colore  
bianco coprente, clip in colori  
coprenti, finiture lucide*

La plastica Green  
Chemical sprigiona  
ioni d'argento che  
svolgono una  
funzione antibatterica.



42 43 35 13

29 green / pad printing 40 x 9 mm  
29 verde / tampografia 40 x 9 mm



65 77 04

54 blue /  
pad printing  
40 x 9 mm  
54 blu /  
tampografia  
40 x 9 mm



# Icon green

---

People and environment friendly.  
*Nel rispetto dell'uomo e della natura.*

---

Testimony of an  
enduring message.

*Testimone di un  
messaggio destinato  
a durare nel tempo.*



Technical information at p. 269  
*Informazioni tecniche a pag. 269*

---

# A significant step forward toward the use of safe plastic.

Un significativo passo avanti nella sicurezza della plastica.



## Nature friendly Vicina all'ambiente

Made of non-toxic plastics, it has been designed to have a long life and to minimise the risk of harmful substances being released into the environment. Using a pen for as long as possible helps to reduce pollution and enables us to give full expression to the concept of promotion.

*Realizzata con materiali atossici, è stata progettata per durare a lungo nel tempo. Una penna che dura di più inquina di meno perchè rimane a lungo nelle nostre mani, massimizzando la diffusione del logo o del messaggio che porta con sé.*



## Green Chemical

It does not contain dioxin, phthalates, bisphenol A, antimony, arsenic, barium, cadmium, chrome, mercury, lead, polybrominated biphenyls (PBBs), polybrominated diphenyl ethers (PBDEs) or deca-BDE, and conforms to RoHS and REACH directives.

*Non contiene: diossina, ftalati, bisfenolo A, antimonio, arsenico, bario, cadmio, cromo, mercurio, piombo, ed è conforme alle normative RoHS e REACH. Bifenili polibromurati (PBB), eteri di difenile (PBDE) e deca BDE sono completamente assenti, ed è conforme alle normative RoHS e REACH.*



## Looking to the future Guarda al futuro

Made of plastic suitable for toy manufacture (according to European standard EN 71-03 and U.S. FDA regulations).

*Prodotta con plastica idonea all'utilizzo nei giocattoli (direttiva europea EN 71 - 03 e direttiva americana FDA).*



## Antibacterial Antibatterica

It is made of antibacterial plastic containing a special additive which releases silver ions that prevent bacteria from colonising the surface of the pen.

*La plastica è antibatterica, grazie ad uno speciale additivo che sprigiona ioni d'argento impedendo ai batteri di depositarsi sulle superfici della penna.*



## Really safe Buona davvero

The plastics employed are compliant with European and American FDA food contact regulations.

*Le plastiche utilizzate sono conformi alla normativa europea e americana FDA per il contatto alimentare.*



## CLP compliant Conforme alle regole

It is rated as non hazardous pursuant to the Regulation on Classification, Labelling and Packaging.

*La plastica non risulta pericolosa per il CLP (classification, labeling and packaging).*



IG2 | BC

Solid white colour barrel,  
solid colours cap, glossy finishes

*Fusto in colore bianco coprente,  
cappuccio in colori coprenti,  
finiture lucide*

Made of special  
plastic used  
to manufacture  
children's toys.

35 red /  
pad printing 35 x 7 mm  
35 rosso /  
tampografia 35 x 7 mm



42

43



13



65



54



04

29 green / pad printing 35 x 7 mm  
29 verde / tampografia 35 x 7 mm

IG2 | C

Solid colours with glossy finish

*Colori solidi con finitura lucida*

Realizzata con  
una plastica  
speciale idonea  
alla produzione  
di giocattoli.

01 white / pad printing 35 x 7 mm  
01 bianco / tampografia 35 x 7 mm



70



42



43



35



13



29

65 dark green / pad printing 35 x 7 mm  
65 verde scuro / tampografia 35 x 7 mm



54



04

# Ethic

---

Elegance and flexibility.  
*Eleganza e flessibilità.*

---

Tailored to the  
customer's  
requirements.

*Costruita a misura  
di cliente.*



The entire Maxema collection is available in recycled plastic on request /  
*Tutta la collezione Maxema è realizzabile in plastica riciclata su richiesta*

Technical information at p. 270  
*Informazioni tecniche a pag. 270*

---

ET900 | MULTICOLOUR

Solid colours with glossy finish, metal chrome finish clip, chromed tip

*Colori coprenti con finitura lucida, clip in metallo cromato, punta cromata*

Designed to outlast passing fashions, like the message it conveys.

Pensata per durare oltre le mode del momento, come il messaggio che deve trasmettere.



18

09

12

R

B

G green / pad printing 55 x 9,5 mm  
G verde / tampografia 55 x 9,5 mm

ET900 | FLAG

Solid colours with glossy finish, metal chrome finish clip, chromed tip

*Colori coprenti con finitura lucida, clip in metallo cromato, punta cromata*



22

15

04

FR

SP

GE

IT / pad printing 55 x 9,5 mm  
IT / tampografia 55 x 9,5 mm

ET900 | C FLAG

Solid colours with glossy finish, metal chrome finish clip, chromed tip

*Colori coprenti con finitura lucida, clip in metallo cromato, punta cromata*



01

01

22 IT

04 IT / pad printing 55 x 9,5 mm  
04 IT / tampografia 55 x 9,5 mm

ET900 | B

Solid colours with glossy finish, metal chrome finish clip, chromed tip

*Colori coprenti con finitura lucida, clip in metallo cromato, punta cromata*



ET900 | BC

Solid colours with glossy finish, metal chrome finish clip, white top, chromed tip and two rings

*Colori coprenti con finitura lucida, clip in metallo cromato, due anelli e punta cromati, tappino bianco*



ET900 | C CR

Solid colours with glossy finish, metal chrome finish clip, chromed tip, top and two rings

*Colori coprenti con finitura lucida, clip in metallo cromato, due anelli, punta e tappino cromati*

chrome



01

70

18

15

25

09

75

27

03 yellow /  
pad printing  
55 x 9,5 mm  
03 giallo /  
tampografia  
55 x 9,5 mm

74 burgundy /  
pad printing  
55 x 9,5 mm  
74 bordeaux /  
tampografia  
55 x 9,5 mm

ET900 | C GOLD

Solid colours with glossy finish, gilded metal finish clip, gilded tip, top and two rings

*Colori coprenti con finitura lucida, clip in metallo dorato, due anelli, punta e tappino dorati*

The chrome or gilded details enhance the pen's elegance.

chrome



12

22

04

01 white /  
screen printing  
45 x 30 mm  
01 bianco /  
serigrafia  
45 x 30 mm

gold



74

27

22

04

I dettagli, cromati o dorati, ne esaltano l'eleganza.

ET900 | AL

Aluminium painted finish barrel, cap and central ring, solid colour two rings and top with glossy finish, metal chrome finish clip, chromed tip

*Fusto, cappuccio e anello centrale verniciati in colore alluminio, due anelli e tappino in colore coprente con finitura lucida, clip in metallo cromato, punta cromata*

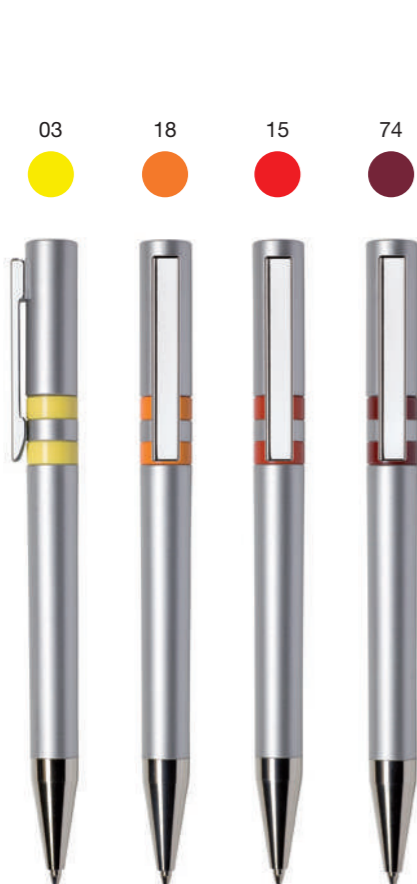

03 18 15 74

09 green / pad printing 55 x 9,5 mm  
09 verde / tampografia 55 x 9,5 mm



12 22 04

Refined,  
flexible design  
for the most  
demanding  
brands.

ET900 | AL CR

Aluminium painted finish barrel, cap and central ring, metal chrome finish clip, chromed tip, top, and two rings

*Fusto, cappuccio e anello centrale verniciati in colore alluminio, clip in metallo cromato, due anelli, tappino e punta cromati*



chrome

Design raffinato  
e flessibile,  
per i brand  
più esigenti.

ET900 | AL FLAG

Aluminium painted finish barrel and cap, solid colour rings with glossy finish, metal chrome finish clip, chromed tip

*Fusto e cappuccio verniciati in colore alluminio, anelli e tappino in colori coprenti con finitura lucida, clip in metallo cromato, punta cromata*



09

IT



ET900 | MET CR

Metallic colours painted finish barrel, cap and central ring, metal chrome finish clip, chromed tip, top and two rings

*Fusto, cappuccio e anello centrale verniciati in colori metallizzati, clip in metallo cromato, due anelli, tappino e punta cromati*

chrome



91 92 83

81 82 89 94

96

85 red /  
pad printing  
55 x 9,5 mm  
85 rosso /  
tampografia  
55 x 9,5 mm

95 blue / pad printing 55 x 9,5 mm  
95 blu / tampografia 55 x 9,5 mm

ET900 | MET AL

Metallic colours painted finish barrel, cap and central ring, metal aluminium painted finish clip, aluminium painted finish tip, top and two rings

*Fusto, cappuccio e anello centrale verniciati in colori metallizzati, clip in metallo verniciato in colore alluminio, due anelli, tappino e punta verniciati in colore alluminio*

al



92 83 85 89 94 95

91 pearl / pad printing 30 x 8 mm  
91 perla / tampografia 30 x 8 mm

96 anthracite / pad printing 30 x 8 mm  
96 antracite / tampografia 30 x 8 mm

# Next

---

The shape for the future  
*La forma che verrà*

---

Sleek, dynamic lines,  
able to boost the  
visibility and identity  
of every brand.

*Scattante e dinamica:  
l'accelerazione positiva  
per ogni brand.*



The entire Maxema collection is available in recycled plastic on request /  
*Tutta la collezione Maxema è realizzabile in plastica riciclata su richiesta*

Technical information at p. 271  
*Informazioni tecniche a pag. 271*

---

NX400 | C CR

Solid colours with glossy finish,  
chromed tip

*Colori coprenti con finitura lucida,  
punta cromata*

01 white / pad printing 50 x 10 mm  
01 bianco / tampografia 50 x 10 mm



70 03 18 15 74 09 12 22

04 black / pad printing 50 x 10 mm  
04 nero / tampografia 50 x 10 mm



NX400 | 30 CR

Transparent colours with glossy  
finish, chromed tip

*Colori trasparenti con finitura lucida,  
punta cromata*



39 52 53 45 55 49 44 40

51 violet /  
pad printing  
35 x 9 mm  
51 viola /  
tampografia  
35 x 9 mm



47 aquamarine /  
pad printing  
35 x 9 mm  
47 acquamarina /  
tampografia  
35 x 9 mm



# Pixel

---

High resolution design.  
*Il design ad alta definizione.*

---

A synthesis of  
contemporary style.

*Sintesi dello stile  
contemporaneo.*



The entire Maxema collection is available in recycled plastic on request /  
*Tutta la collezione Maxema è realizzabile in plastica riciclata su richiesta*

Technical information at p. 272  
*Informazioni tecniche a pag. 272*

---

PX40 | MATT CB

Solid colour barrel with matt finish, solid glossy white colour clip and push-button

Colours with matt finish and white clip: an easy, gritty combination.

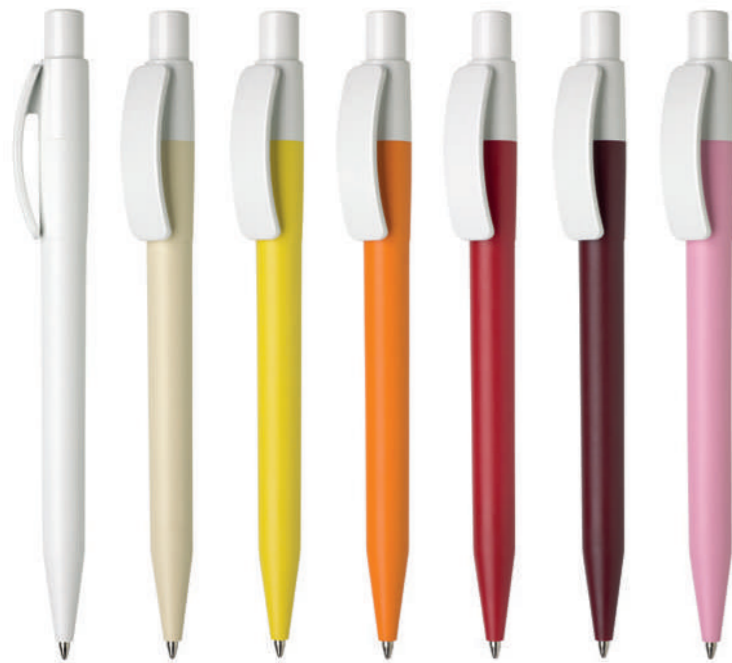

01 70 03 18 15 74 60

61 magenta / pad printing 30 x 8 mm  
61 magenta / tampografia 30 x 8 mm



71 25 73

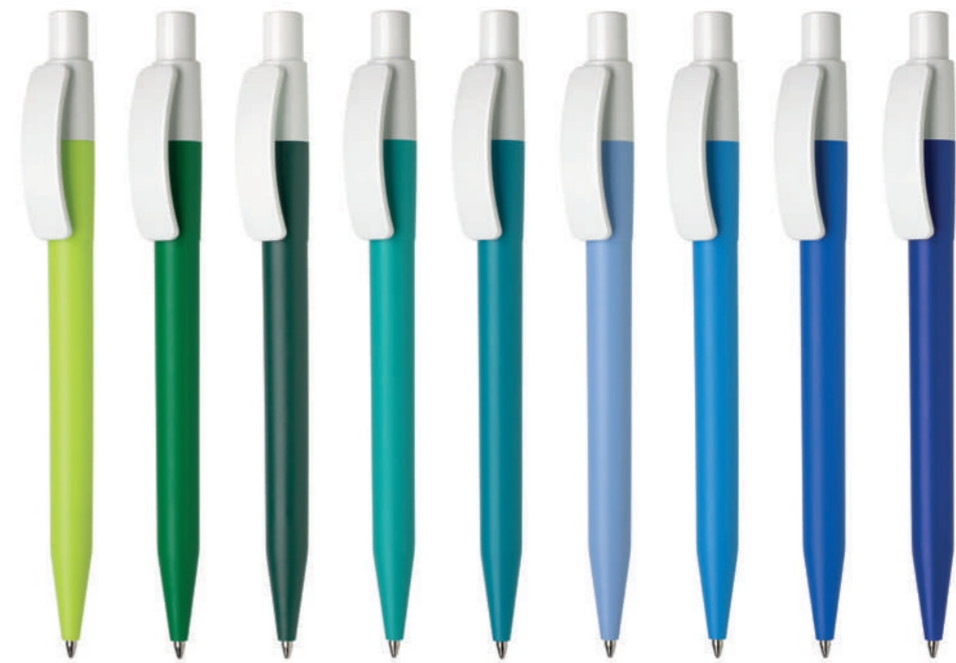

79 09 75 26 27 64 77 12 22

05 grey / pad printing 30 x 8 mm  
05 grigio / tampografia 30 x 8 mm

Fusto in colore coprente con finitura satinata, clip e tappino in colore bianco coprente lucido

Colori con finitura matt e clip bianca: una combinazione facile e grintosa.



04

PX40 | MATT CR

Solid colour barrel with matt finish,  
solid glossy colour clip, chromed  
push-button

Fusto in colore coprente con finitura  
satinata, clip in colore coprente  
lucido, tappino cromato



01 70

03 yellow /  
pad printing  
30 x 8 mm  
03 giallo /  
tampografia  
30 x 8 mm



18 15 74 60 61 71 25

73 brown / pad printing 30 x 8 mm  
73 marrone / tampografia 30 x 8 mm



79 09 75

26 aquamarine /  
pad printing  
30 x 8 mm  
26 acquamarina /  
tampografia  
30 x 8 mm



27



77 12 22 05 04

64 pastel blue / pad printing 60 x 9 mm  
64 azzurro pastello / tampografia 60 x 9 mm

PX40 | B

Solid white colour barrel and push-button, solid colours clip, glossy finishes

*Fusto e tappino in colore bianco coprente, clip in colori coprenti, finiture lucide*



01 03 18 15



74 burgundy / pad printing 30 x 8 mm  
74 bordeaux / tampografia 30 x 8 mm



09 12



04

22 blue / pad printing 30 x 8 mm  
22 blu / tampografia 30 x 8 mm



PX40 | C

Solid colours with glossy finish  
*Colori coprenti con finitura lucida*



70 03 18 15

09 green / pad printing 30 x 8 mm  
09 verde / tampografia 30 x 8 mm



12 22

04 black / pad printing 30 x 8 mm  
04 nero / tampografia 30 x 8 mm



PX40 | 30

Transparent colours with glossy finish

*Colori trasparenti con finitura lucida*



47 aquamarine / pad printing  
30 x 8 mm 47 ac-  
quamarina /  
tampografia  
30 x 8 mm



39 52 53 45 51 55 49



44 40

PX40 | FROST NEUTRAL

Transparent colours, matt finish barrel, glossy finish clip and push-button

*Colori trasparenti, fusto con finitura satinata, clip e tappino con finitura lucida*

The ventilated push-button is compliant with EU laws for small components.



53 orange / pad printing  
30 x 8 mm  
53 arancio /  
tampografia  
30 x 8 mm

55 dark violet / pad printing  
30 x 8 mm  
55 viola scuro /  
tampografia  
30 x 8 mm

52 45 51



49 47 44 40

Il tappino ventilato è conforme alle normative CEE sui piccoli componenti.



PX40 | FROST

Transparent colours, matt finish barrel, glossy finish clip and push-button



39 52 53 45 59

41 magenta / pad printing 30 x 8 mm  
41 magenta / tampografia 30 x 8 mm



31 lilac / pad printing 30 x 8 mm  
31 lilla / tampografia 30 x 8 mm



51 55



37 38



78 lime / pad printing 30 x 8 mm  
78 lime / tampografia 30 x 8 mm



49 34 67 44 40 50

Colori trasparenti, fusto con finitura satinata, clip e tappino con finitura lucida

PX40 | GOM C CR

Solid colour barrel with rubber finish, solid colour clip with glossy finish, chromed push-button

*Fusto in colore coprente gommato, clip in colore coprente con finitura lucida, tappino cromato*

15 red / pad printing 30 x 8 mm  
15 rosso / tampografia 30 x 8 mm



18

74

61

25

79

09

22

04 black / pad printing 30 x 8 mm  
04 nero / tampografia 30 x 8 mm

PX40 | GOM 30 CR

Solid colour barrel with rubber finish, transparent colour clip with glossy finish, chromed push-button

*Fusto in colore coprente gommato, clip in colore trasparente con finitura lucida, tappino cromato*

47 aquamarine / pad printing 30 x 8 mm  
47 acquamarina / tampografia 30 x 8 mm



53

45

41 magenta / pad printing 30 x 8 mm  
41 magenta / tampografia 30 x 8 mm

55

49

44

50

# Bay

---

Casual and attractive  
*Disinvolta e accattivante*

Draws attention  
for its simplicity.

*Attrae per la  
sua semplicità.*



The entire Maxema collection is available in recycled plastic on request /  
*Tutta la collezione Maxema è realizzabile in plastica riciclata su richiesta*

Technical information at p. 273  
*Informazioni tecniche a pag. 273*

B500 | MATT BC

Solid white colour barrel,  
solid colours cap, matt finishes

Fusto in colore bianco coprente,  
cappuccio in colori coprenti,  
finiture satinare



70 03 18 15 74

60 pink / pad printing 30 x 7 mm  
60 rosa / tampografia 30 x 7 mm



61 71 25 73 79



75 dark green / pad printing 30 x 7 mm  
75 verde scuro / tampografia 30 x 7 mm  
—  
pad printing 60 x 7 mm  
tampografia 60 x 7 mm

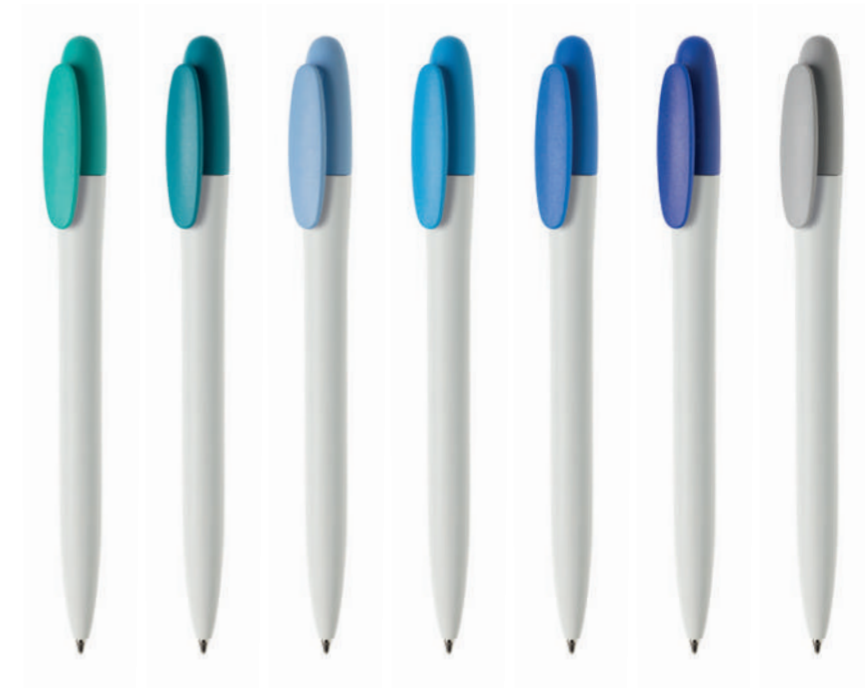

26 27 64 77 12 22 05

04 black / pad printing 60 x 7 mm  
04 nero / tampografia 60 x 7 mm



B500 | MATT

Solid colours with matt finish

Effetto satinato:  
raffinata  
delicatezza  
in 22 colori.

Colori coprenti con finitura satinata

Delicately refined  
matt finish in 22  
colours.

01 white / pad printing 30 x 7 mm  
01 bianco / tampografia 30 x 7 mm



70 03 18 15 74 60 61 71 25

73 brown / pad printing 60 x 7 mm  
73 marrone / tampografia 60 x 7 mm



79 09 75 26

27 octan green / pad printing 30 x 7 mm  
27 ottanio / tampografia 30 x 7 mm



64 77 12 22 05 04

B500 | BC

Solid white colour barrel,  
solid colours cap, glossy finishes

*Fusto in colore bianco coprente,  
cappuccio in colori coprenti,  
finiture lucide*

B500 | C

Solid colours with glossy finish

*Colori coprenti con finitura lucida*



03 18 15 25 09 12



**Panasonic**



04



01 70 03 18 15 74 09 12 22



**MANOR**

22 blue / pad printing 60 x 7 mm  
22 blu / tampografia 60 x 7 mm

04 black / pad printing 30 x 7 mm  
04 nero / tampografia 30 x 7 mm

Transparent colours with glossy finish

Colori trasparenti con finitura lucida



39 52 53



45 red /  
pad printing  
30 x 7 mm  
45 rosso /  
tampografia  
30 x 7 mm



51 55 49



47 aquamarine /  
pad printing  
30 x 7 mm  
47 acquamarina /  
tampografia  
30 x 7 mm



44 40

Transparent colours with matt finish

Colori trasparenti con finitura satinata



39 neutral / pad printing 60 x 7 mm  
39 neutro / tampografia 60 x 7 mm



52 53 45 51

55 dark violet / pad printing 30 x 7 mm  
55 viola scuro / tampografia 30 x 7 mm



49 44 40

Technical information  
*Informazioni tecniche*



# Tag green Recycled Antibacterial

NEW

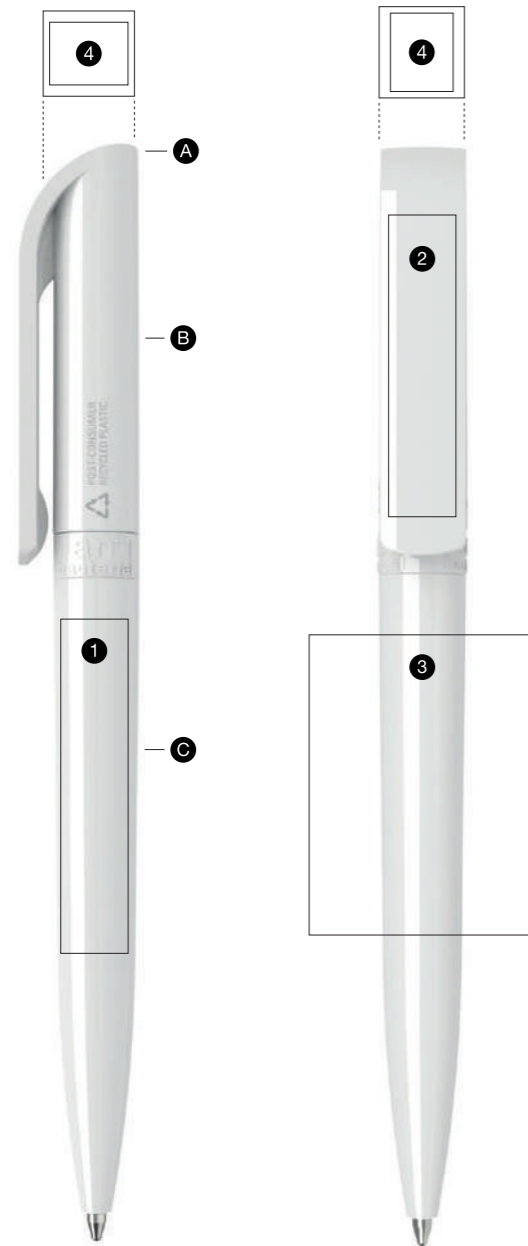

## Components / Componenti

- A Plug / tassello
- B Clip / clip
- C Barrel / fusto

## Print area / Area stampabile

- 1 pad printing / tampografia 45 x 9 mm
- 2 pad printing / tampografia 40 x 9 mm
- 3 screen printing / serigrafia 40 x 30 mm
- 4 pad printing / tampografia 8 x 10 mm

## Features / Caratteristiche

twist-action / meccanismo a rotazione

recycled plastic derived from post-consumer products, certified and compliant with RoHS and REACH regulations / plastica riciclata derivante da prodotti post-consumo certificata e conforme alle normative RoHS e REACH.

ISO 22196:2011 certified antimicrobial additive / additivo antimicrobico certificato ISO 22196:2011

Jumbo refill, blue and black ink / refill Jumbo, inchiostro blu e nero

available in glossy finish / disponibile con superfici lucide

QUALITY NOT QUANTITY

The entire Maxema collection is available in recycled plastic on request / Tutta la collezione Maxema è realizzabile in plastica riciclata su richiesta

TAKE IT SAFE, TAKE IT EASY.

Tag green is available in antibacterial plastic / La penna Tag green è disponibile in plastica antibatterica

# Icon green Recycled Antibacterial

NEW

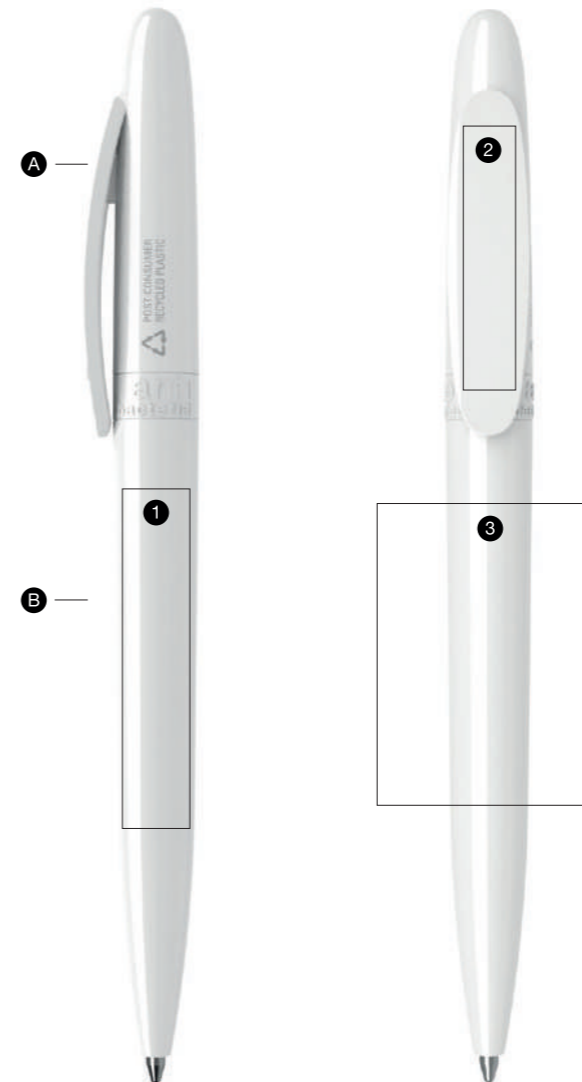

## Components / Componenti

- A Cap / cappuccio
- B Barrel / fusto

## Print area / Area stampabile

- 1 pad printing / tampografia 45 x 9 mm
- 2 pad printing / tampografia 35 x 7 mm
- 3 screen printing / serigrafia 40 x 30 mm

## Features / Caratteristiche

twist-action / meccanismo a rotazione

recycled plastic derived from post-consumer products, certified and compliant with RoHS and REACH regulations / plastica riciclata derivante da prodotti post-consumo certificata e conforme alle normative RoHS e REACH.

ISO 22196:2011 certified antimicrobial additive / additivo antimicrobico certificato ISO 22196:2011

Jumbo refill, blue and black ink / refill Jumbo, inchiostro blu e nero

available in glossy finish / disponibile con superfici lucide

QUALITY NOT QUANTITY

The entire Maxema collection is available in recycled plastic on request / Tutta la collezione Maxema è realizzabile in plastica riciclata su richiesta

TAKE IT SAFE, TAKE IT EASY.

Icon green is available in antibacterial plastic / La penna Icon green è disponibile in plastica antibatterica

# Mood Metal



## Components / Componenti

- A Push-button / tappino
- B Clip
- C Barrel / fusto
- D Tip / punta

## Print area / Area stampabile

- 1 laser engraving 30 x 7 mm  
incisione laser 30 x 7 mm
- 2 pad printing / tampografia  
40 x 9 mm

## Features / Caratteristiche

retractable with return spring /  
meccanismo a scatto, con molla  
di ritorno

metal push-button, barrel and tip,  
individually processed with diamond  
mirror face finish / tappino, fusto e  
punta in metallo, lavorati singolarmente  
con finitura a specchio diamantata

clip made of non-toxic, highly resistant  
ABS plastic / clip realizzata in plastica  
ABS atossica e ad alta resistenza

“Parker type” refill, blue and black ink /  
refill “tipo Parker”, inchiostro blu e nero

**Fast Dry Gel** blue and black ink available  
on request /  
Refill Gel Fast Dry blu e nero disponibile  
su richiesta



The entire Maxema collection is available  
in recycled plastic on request /  
Tutta la collezione Maxema è realizzabile  
in plastica riciclata su richiesta

# Mood

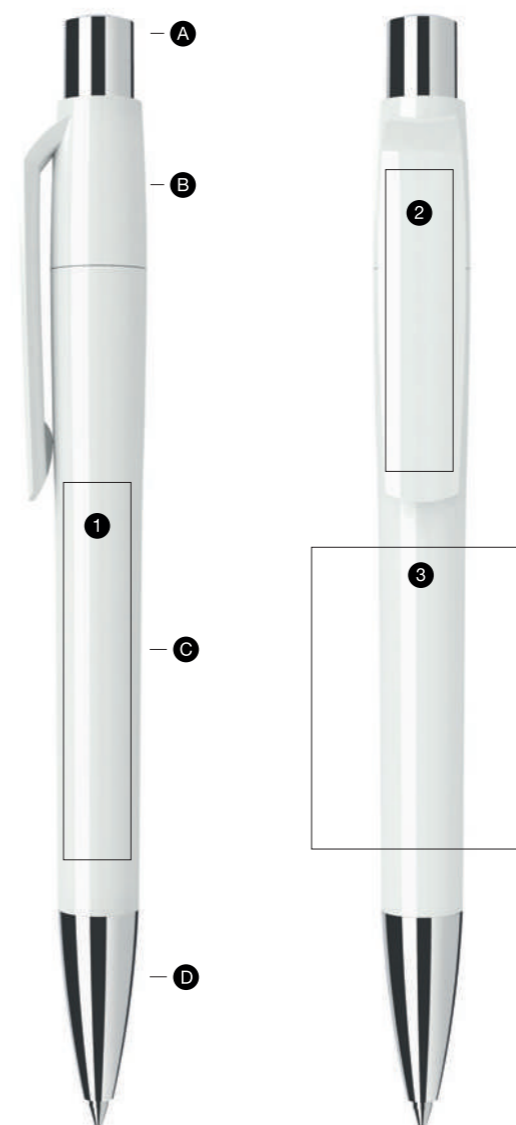

## Components / Componenti

- A Push-button / tappino
- B Clip
- C Barrel / fusto
- D Tip / punta

## Print area / Area stampabile

- 1 pad printing / tampografia  
46 x 9 mm
- 2 pad printing / tampografia  
40 x 9 mm
- 3 screen printing / serigrafia  
40 x 30 mm

## Features / Caratteristiche

retractable with return spring /  
meccanismo a scatto, con molla  
di ritorno

made of non-toxic, highly resistant  
ABS plastic / realizzata in plastica ABS  
atossica e ad alta resistenza

metal tip and push-button,  
individually processed with diamond  
mirror face finish / tappino e punta in  
metallo, lavorati singolarmente con  
finitura a specchio diamantata

“Parker type” refill, blue and black ink /  
refill “tipo Parker”, inchiostro blu e nero

available in glossy or rubberised finish /  
disponibile con superfici lucide  
o gommate

rubberised barrel versions are only  
printable on the clip / le versioni con  
fusto gommato sono stampabili solo  
su clip

**Fast Dry Gel** blue and black ink available  
on request /  
Refill Gel Fast Dry blu e nero disponibile  
su richiesta



The entire Maxema collection is available  
in recycled plastic on request /  
Tutta la collezione Maxema è realizzabile  
in plastica riciclata su richiesta

# Icon Pure

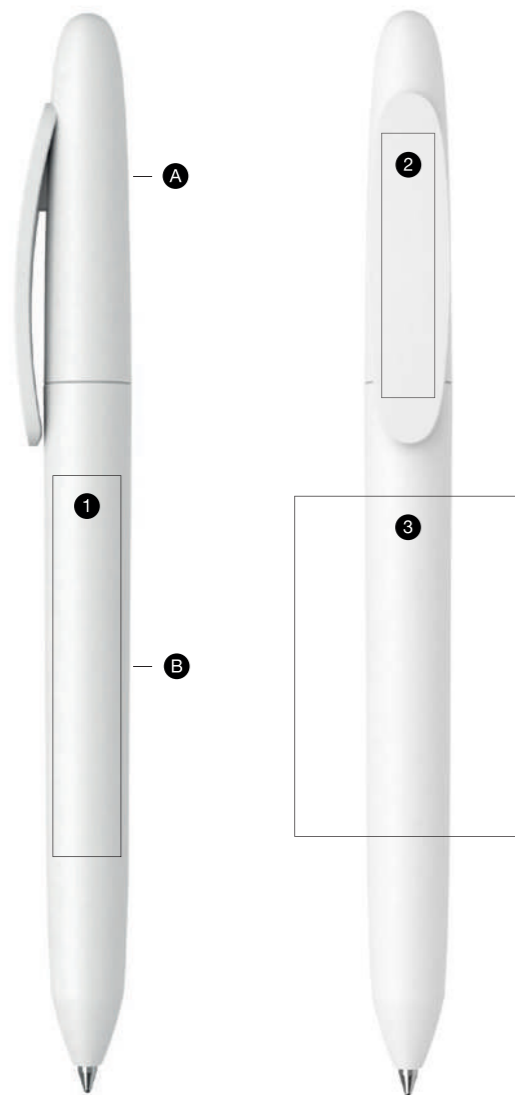

## Components / Componenti

- A** Cap / cappuccio
- B** Barrel / fusto

## Print area / Area stampabile

- 1** pad printing / tampografia 50 x 9 mm
- 2** pad printing / tampografia 35 x 7 mm
- 3** screen printing / serigrafia 45 x 30 mm

## Features / Caratteristiche

twist-action / meccanismo a rotazione

made of non-toxic highly resistant ABS plastic / realizzata in plastica ABS, atossica e ad alta resistenza

Jumbo refill, blue and black ink / refill Jumbo, inchiostro blu e nero

available in rubberised and matt recycled finish / disponibile con superfici gommate e satinare riciclate

printing must be carried out before rubber coating or, alternatively, using specific inks for rubberised surfaces / la stampa deve essere eseguita prima della gommatura o, in alternativa, con inchiostri specifici per superfici gommate

 IC8 — RECYCLED PLASTIC  
PLASTICA RICICLATA

Small imperfections and slight colour variations are to be considered intrinsic features of the recycled material deriving from the post-consumer sector. / Piccole imperfezioni e lievi variazioni cromatiche sono da considerarsi caratteristiche intrinseche del materiale riciclato derivante dal post-consumo.

**Fast Dry Gel** blue and black ink available on request /  
Refill Gel Fast Dry blu e nero disponibile su richiesta



The entire Maxema collection is available in recycled plastic on request /  
Tutta la collezione Maxema è realizzabile in plastica riciclata su richiesta

# Flow Pure

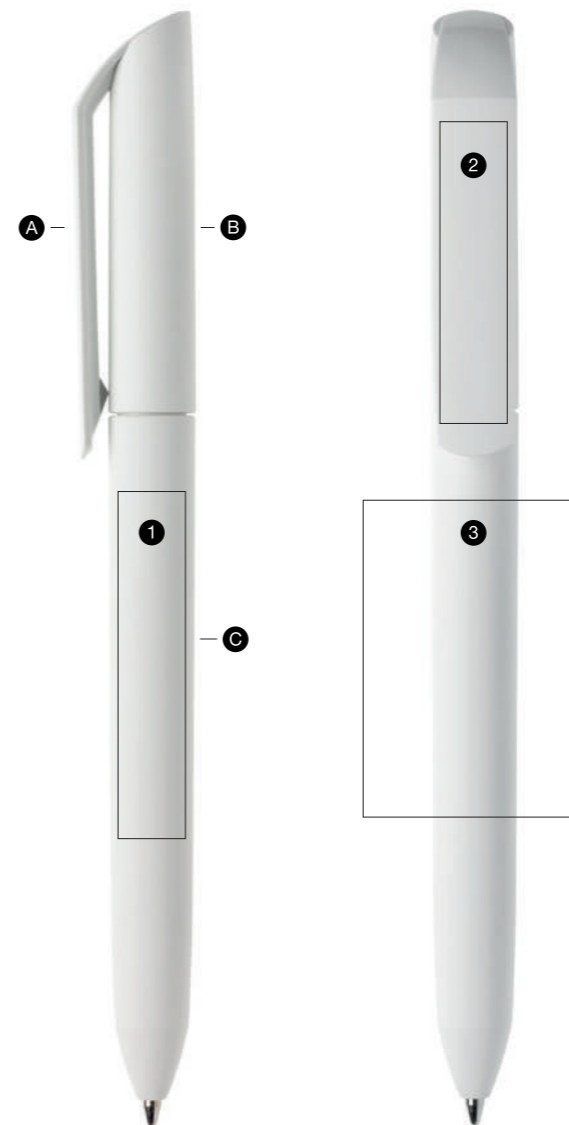

## Components / Componenti

- A** Clip
- B** Cap / cappuccio
- C** Barrel / fusto

## Print area / Area stampabile

- 1** pad printing / tampografia 50 x 9 mm
- 2** pad printing / tampografia 40 x 9 mm
- 3** screen printing / serigrafia 45 x 30 mm

## Features / Caratteristiche

twist-action / meccanismo a rotazione

made of non-toxic highly resistant ABS plastic / realizzata in plastica ABS, atossica e ad alta resistenza

Jumbo refill, blue and black ink / refill Jumbo, inchiostro blu e nero

available in glossy, matt or rubberised finish / disponibile con superfici lucide, satinare o gommate

 F2 P — RECYCLED PLASTIC  
PLASTICA RICICLATA

Small imperfections and slight colour variations are to be considered intrinsic features of the recycled material deriving from the post-consumer sector. / Piccole imperfezioni e lievi variazioni cromatiche sono da considerarsi caratteristiche intrinseche del materiale riciclato derivante dal post-consumo.



The entire Maxema collection is available in recycled plastic on request /  
Tutta la collezione Maxema è realizzabile in plastica riciclata su richiesta

**TAKE IT SAFE,  
TAKE IT EASY.**

Flow Pure is available in white antibacterial plastic /  
La penna Flow Pure è disponibile in plastica antibatterica bianca

**Fast Dry Gel** blue and black ink available on request /  
Refill Gel Fast Dry blu e nero disponibile su richiesta

# Flow

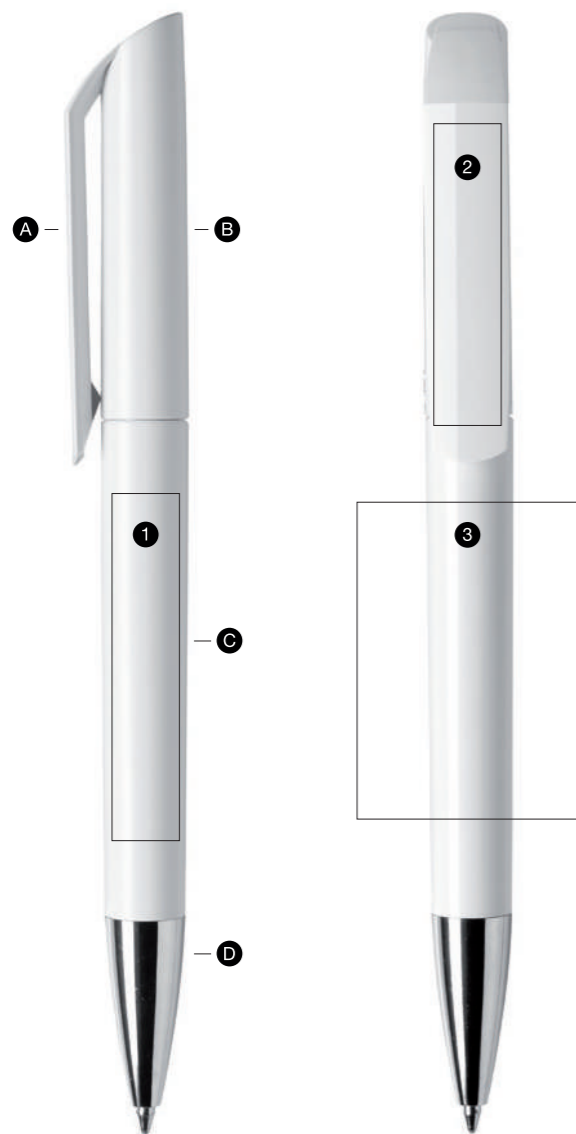

## Components / Componenti

- A Clip
- B Cap / cappuccio
- C Barrel / fusto
- D Tip / punta

## Print area / Area stampabile

- 1 pad printing / tampografia  
46 x 9 mm
- 2 pad printing / tampografia  
40 x 9 mm
- 3 screen printing / serigrafia  
42 x 30 mm

## Features / Caratteristiche

twist-action / meccanismo a rotazione

made of non-toxic highly resistant ABS plastic / realizzata in plastica ABS, atossica e ad alta resistenza

galvanic process used to chrome tip / la cromatura della punta è ottenuta con trattamento galvanico

Jumbo refill, blue and black ink / refill Jumbo, inchiostro blu e nero

available in glossy, matt or rubberised finish / disponibile con superfici lucide, satinare o gommate

in the Texture version, the entire matt cap features a honeycomb design / nella versione Texture il cappuccio satinato è percorso interamente da una trama a nido d'ape

**Fast Dry Gel** blue and black ink available on request /  
Refill Gel Fast Dry blu e nero disponibile su richiesta



The entire Maxema collection is available in recycled plastic on request /  
Tutta la collezione Maxema è realizzabile in plastica riciclata su richiesta

# Dot

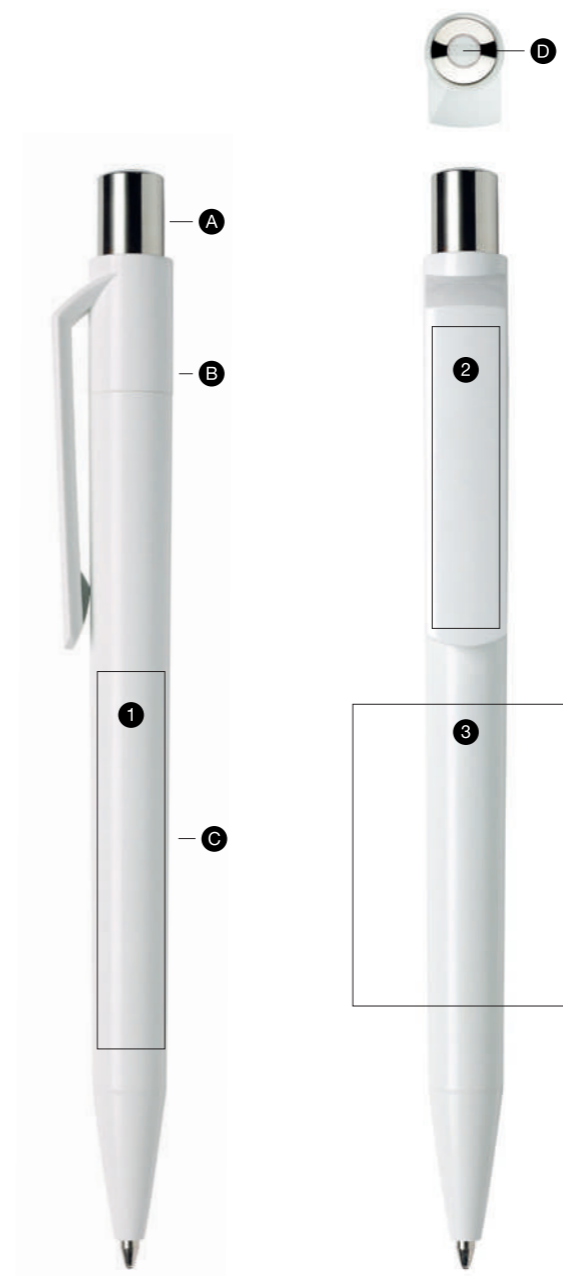

## Components / Componenti

- A Push-button / tappino
- B Clip
- C Barrel / fusto
- D Little sphere / piccola sfera

## Print area / Area stampabile

- 1 pad printing / tampografia  
50 x 9 mm
- 2 pad printing / tampografia  
40 x 9 mm
- 3 screen printing / serigrafia  
40 x 30 mm

## Features / Caratteristiche

retractable with return spring / meccanismo a scatto, con molla di ritorno

made of non-toxic, highly resistant ABS plastic / realizzata in plastica ABS atossica e ad alta resistenza

galvanic process used to chrome and gold ABS push-button / la cromatura e la doratura del tappino sono ottenute con trattamento galvanico

Jumbo refill, blue and black ink / refill Jumbo, inchiostro blu e nero

available in glossy, matt or rubberised finish / disponibile con superfici lucide, satinare o gommate

rubberised barrel versions are only printable on the clip / le versioni con fusto gommato sono stampabili solo su clip

D1 – RECYCLED PLASTIC  
PLASTICA RICICLATA

Small imperfections and slight colour variations are to be considered intrinsic features of the recycled material deriving from the post-consumer sector. / Piccole imperfezioni e lievi variazioni cromatiche sono da considerarsi caratteristiche intrinseche del materiale riciclato derivante dal post-consumo.

**Fast Dry Gel** blue and black ink available on request /  
Refill Gel Fast Dry blu e nero disponibile su richiesta



The entire Maxema collection is available in recycled plastic on request /  
Tutta la collezione Maxema è realizzabile in plastica riciclata su richiesta

**TAKE IT SAFE, TAKE IT EASY.**

Dot is available in coloured antibacterial plastic /  
La penna Dot è disponibile in plastica antibatterica colorata

# Zink

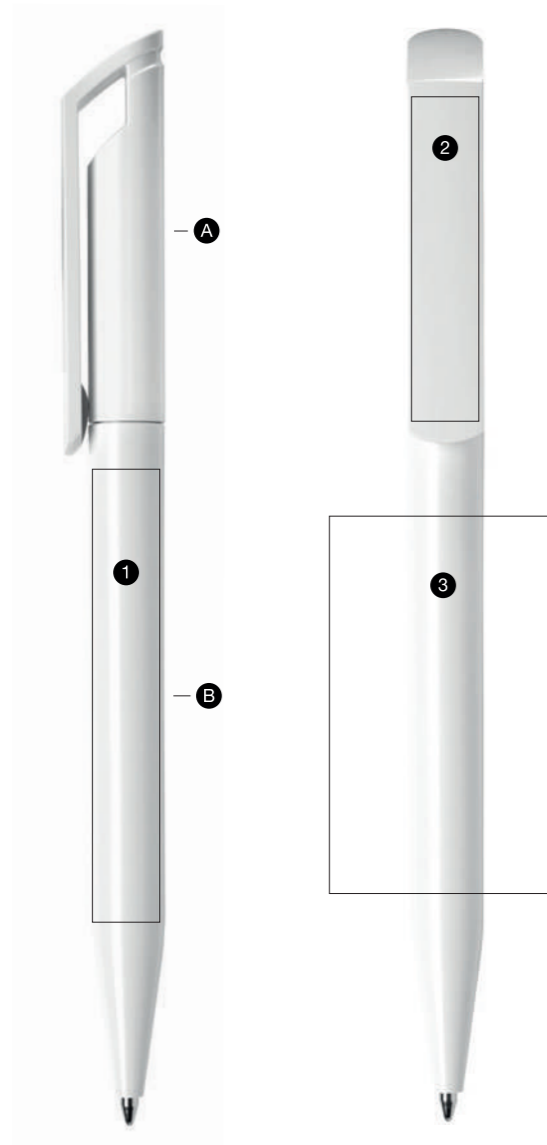

## Components / Componenti

- A** Cap / cappuccio
- B** Barrel / fusto

## Print area / Area stampabile

- 1** pad printing / tampografia 60 x 9 mm
- 2** pad printing / tampografia 43 x 9 mm
- 3** screen printing / serigrafia 50 x 30 mm

## Features / Caratteristiche

twist-action / meccanismo a rotazione

made of non-toxic, highly resistant ABS plastic / realizzata in plastica ABS atossica e ad alta resistenza

Jumbo refill, blue and black ink / refill Jumbo, inchiostro blu e nero

available in glossy finish / disponibile con superfici lucide

 Z1 — RECYCLED PLASTIC  
PLASTICA RICICLATA

Small imperfections and slight colour variations are to be considered intrinsic features of the recycled material deriving from the post-consumer sector. / Piccole imperfezioni e lievi variazioni cromatiche sono da considerarsi caratteristiche intrinseche del materiale riciclato derivante dal post-consumo.

**Fast Dry Gel** blue and black ink available on request /  
Refill Gel Fast Dry blu e nero disponibile su richiesta



The entire Maxema collection is available in recycled plastic on request /  
Tutta la collezione Maxema è realizzabile in plastica riciclata su richiesta

**TAKE IT SAFE,  
TAKE IT EASY.**

Zink is available in white antibacterial plastic /  
La penna Zink è disponibile in plastica antibatterica bianca

# View



## Components / Componenti

- A** Clip
- B** Cap / cappuccio
- C** Barrel / fusto
- D** Punta / tip

## Print area / Area stampabile

- 1** pad printing / tampografia 40 x 6 mm
- 2** laser engraving 30 x 7 mm  
incisione laser 30 x 7 mm
- 3** pad printing / tampografia 47 x 9 mm
- 4** screen printing / serigrafia 42 x 30 mm

## Features / Caratteristiche

twist-action / meccanismo a rotazione

made of non-toxic, highly resistant ABS plastic / realizzata in plastica ABS atossica e ad alta resistenza

metal chrome finish clip available for laser engraving and pad printing / clip in metallo cromato, disponibile per incisione laser e tampografia

galvanic process used to chrome tip / la cromatura della punta è ottenuta con trattamento galvanico

Jumbo refill, blue and black ink / refill Jumbo, inchiostro blu e nero

available in glossy, rubberised or aluminium painted finish / disponibile con superfici lucide, gommate o verniciate in colore alluminio

**Fast Dry Gel** blue and black ink available on request /  
Refill Gel Fast Dry blu e nero disponibile su richiesta



The entire Maxema collection is available in recycled plastic on request /  
Tutta la collezione Maxema è realizzabile in plastica riciclata su richiesta

# Tag

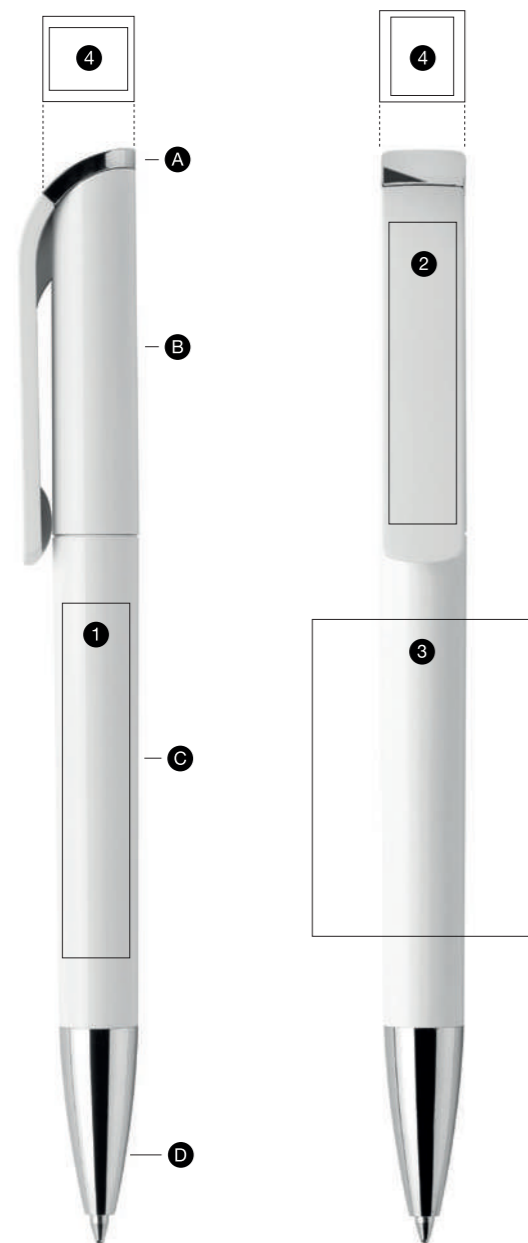

## Components / Componenti

- A Plug / tassello
- B Clip / clip
- C Barrel / fusto
- D Tip / punta

## Print area / Area stampabile

- 1 pad printing / tampografia  
47 x 9 mm
- 2 pad printing / tampografia  
40 x 9 mm
- 3 screen printing / serigrafia  
42 x 30 mm
- 4 pad printing / tampografia  
8 x 10 mm

## Features / Caratteristiche

twist-action / meccanismo a rotazione

made of non-toxic, highly resistant ABS plastic / realizzata in plastica ABS atossica e ad alta resistenza

galvanic process used to chrome tip and upper plug / la cromatura della punta e del tassello superiore è ottenuta con trattamento galvanico

Jumbo refill, blue and black ink / refill Jumbo, inchiostro blu e nero

available in glossy, matt and metallic or aluminium painted finish / disponibile con superfici lucide, satinare o verniciate con colori metallizzati o alluminio

**Fast Dry Gel** blue and black ink available on request /  
Refill Gel Fast Dry blu e nero disponibile su richiesta



The entire Maxema collection is available in recycled plastic on request /  
Tutta la collezione Maxema è realizzabile in plastica riciclata su richiesta

# Icon

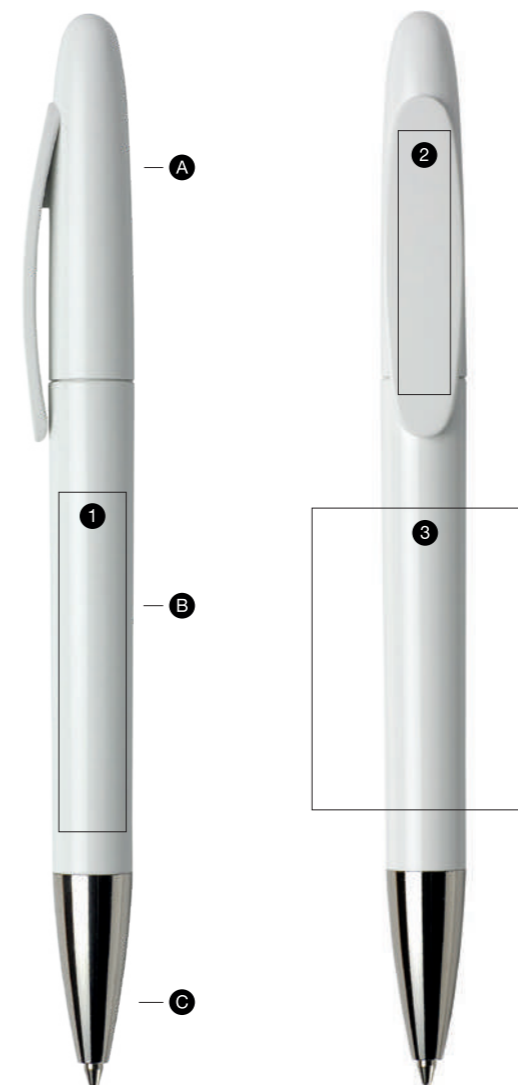

## Components / Componenti

- A Cap / cappuccio
- B Barrel / fusto
- C Tip / punta

## Print area / Area stampabile

- 1 pad printing / tampografia  
45 x 9 mm
- 2 pad printing / tampografia  
35 x 7 mm
- 3 screen printing / serigrafia  
40 x 30 mm

## Features / Caratteristiche

twist-action / meccanismo a rotazione

made of non-toxic, highly resistant ABS plastic / realizzata in plastica ABS, atossica e ad alta resistenza

galvanic process used to chrome and gild ABS tip / la cromatura e la doratura della punta in ABS sono ottenute con trattamento galvanico

Jumbo refill, blue and black ink / refill Jumbo, inchiostro blu e nero

available in glossy, matt and metallic or aluminium painted finish / disponibile con superfici lucide, satinare o verniciate in colori metallizzati o alluminio

**Fast Dry Gel** blue and black ink available on request /  
Refill Gel Fast Dry blu e nero disponibile su richiesta



The entire Maxema collection is available in recycled plastic on request /  
Tutta la collezione Maxema è realizzabile in plastica riciclata su richiesta

# Tag green

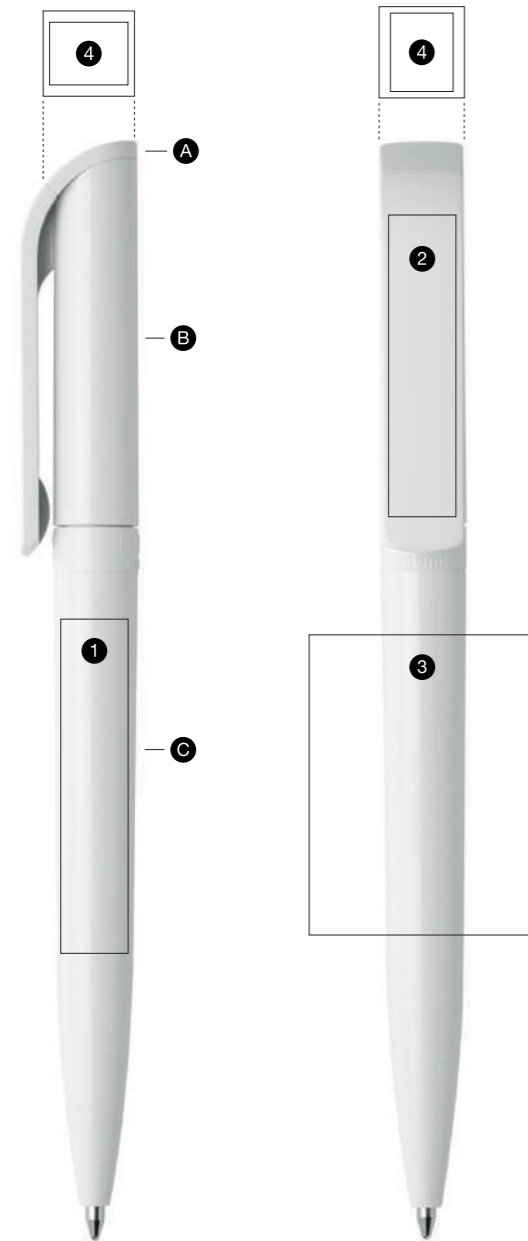

## Components / Componenti

- A Plug / tassello
- B Clip / clip
- C Barrel / fusto

## Print area / Area stampabile

- 1 pad printing / tampografia  
45 x 9 mm
- 2 pad printing / tampografia  
40 x 9 mm
- 3 screen printing / serigrafia  
40 x 30 mm
- 4 pad printing / tampografia  
8 x 10 mm

## Features / Caratteristiche

twist-action / meccanismo a rotazione

made of non-toxic, highly resistant special ABS plastic certified for use in toy manufacture / realizzata in plastica ABS speciale, ad alta resistenza, atossica e certificata per l'utilizzo nei giocattoli

antibacterial / antibatterico

X20 refill, blue and black ink / refill X-20, inchiostro blu e nero

available in glossy finish / disponibile con superfici lucide

# Icon green

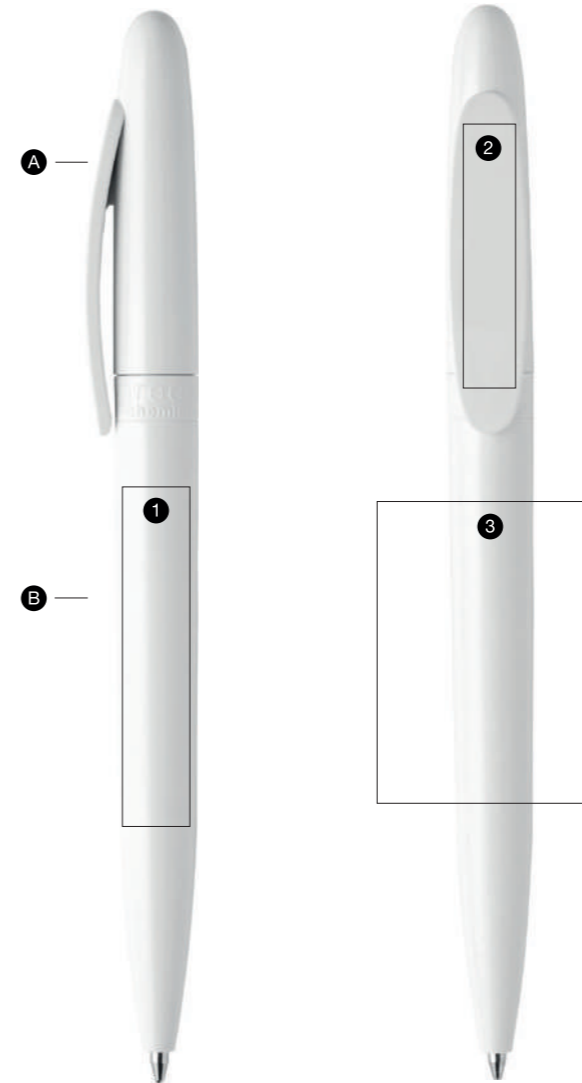

## Components / Componenti

- A Cap / cappuccio
- B Barrel / fusto

## Print area / Area stampabile

- 1 pad printing / tampografia  
45 x 9 mm
- 2 pad printing / tampografia  
35 x 7 mm
- 3 screen printing / serigrafia  
40 x 30 mm

## Features / Caratteristiche

twist-action / meccanismo a rotazione

made of non-toxic, highly resistant special ABS plastic certified for use in toy manufacture / realizzata in plastica ABS speciale, ad alta resistenza, atossica e certificata per l'utilizzo nei giocattoli

antibacterial / antibatterica

X20 refill, blue and black ink / refill X20, inchiostro blu e nero

available in glossy finish / disponibile con superfici lucide

# Ethic



## Components / Componenti

- A Small cap / tappino
- B Cap / cappuccio
- C Rings / anelli
- D Barrel / fusto
- E Tip / punta

## Print area / Area stampabile

- 1 pad printing / tampografia  
30 x 8 mm
- 2 screen printing / serigrafia  
45 x 30 mm
- 3 pad printing / tampografia  
55 x 9,5 mm

## Features / Caratteristiche

twist-action / meccanismo a rotazione

made of non-toxic, highly resistant  
ABS plastic / realizzata in plastica ABS,  
atossica e ad alta resistenza

metal clip with chrome, gilded  
or aluminium painted finish / clip in  
metallo, con finitura cromata,  
dorata o verniciata color alluminio

galvanic process used to chrome  
or to gild ABS parts / la cromatura e  
la doratura delle parti in ABS sono  
ottenute con trattamento galvanico

Jumbo refill, blue and black ink / refill  
Jumbo, inchiostro blu e nero

available in glossy and metallic  
or aluminium painted finish / disponibile  
con superfici lucide o verniciate in  
colori metallizzati o alluminio

**Fast Dry Gel** blue and black ink available  
on request /  
Refill Gel Fast Dry blu e nero disponibile  
su richiesta



The entire Maxema collection is available  
in recycled plastic on request /  
Tutta la collezione Maxema è realizzabile  
in plastica riciclata su richiesta

# Next

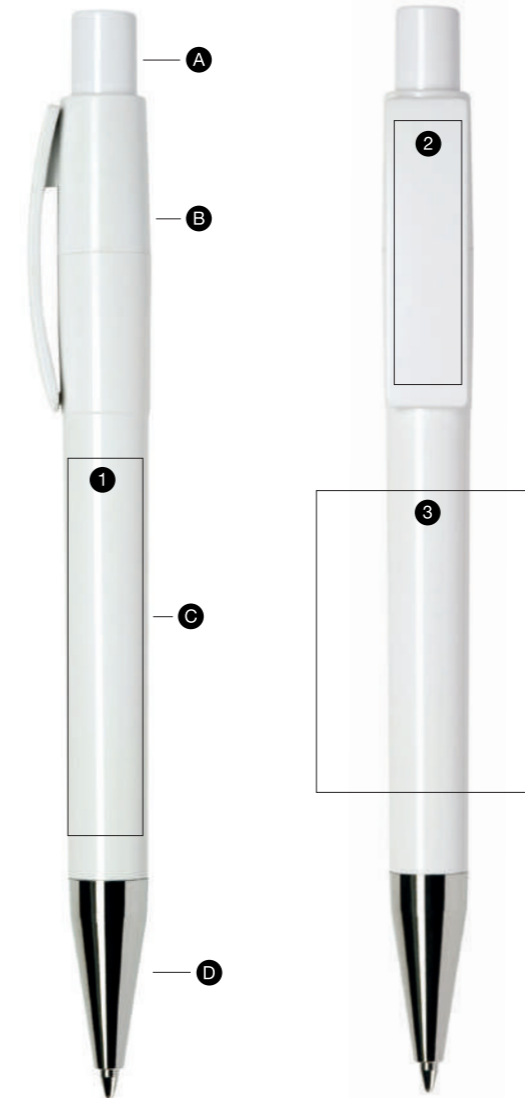

## Components / Componenti

- A Push-button / tappino
- B Clip
- C Barrel / fusto
- D Tip / punta

## Print area / Area stampabile

- 1 pad printing / tampografia  
50 x 10 mm
- 2 pad printing / tampografia  
35 x 9 mm
- 3 screen printing / serigrafia  
40 x 30 mm

## Features / Caratteristiche

retractable with return spring /  
meccanismo a scatto, con molla  
di ritorno

ventilated push-button  
tappino ventilato

made of non-toxic, highly resistant  
ABS plastic / realizzata in plastica ABS,  
atossica e ad alta resistenza

Jumbo refill, blue and black ink /  
refill Jumbo, inchiostro blu e nero

the barrel is available in glossy finish /  
il fusto è disponibile con superfici lucide

galvanic process used to chrome  
the ABS tip / la cromatura della punta  
in ABS è ottenuta con trattamento  
galvanico

**Fast Dry Gel** blue and black ink available  
on request /  
Refill Gel Fast Dry blu e nero disponibile  
su richiesta



The entire Maxema collection is available  
in recycled plastic on request /  
Tutta la collezione Maxema è realizzabile  
in plastica riciclata su richiesta



# Pixel

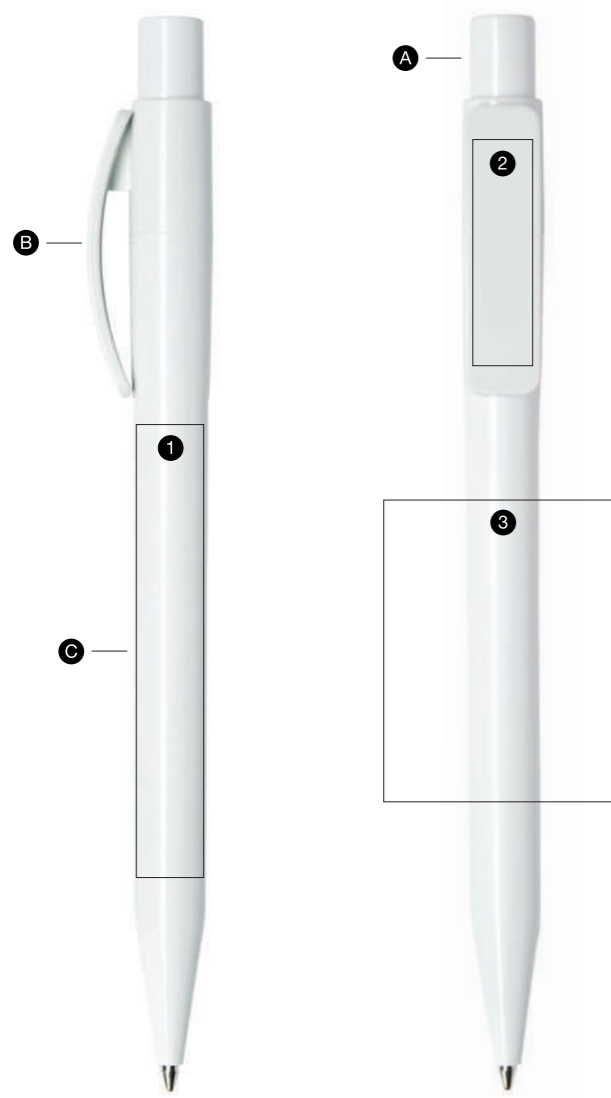

## Components / Componenti

- A Push-button / tappino
- B Clip
- C Barrel / fusto

## Print area / Area stampabile

- 1 pad printing / tampografia 60 x 9 mm
- 2 pad printing / tampografia 30 x 8 mm
- 3 screen printing / serigrafia 40 x 31 mm

## Features / Caratteristiche

retractable / meccanismo a scatto  
ventilated push-button / tappino ventilato

made of non-toxic, highly resistant ABS plastic / realizzata in plastica ABS, atossica e ad alta resistenza

X-20 refill, blue and black ink / refill X 20, inchiostro blu e nero

the barrel is available in glossy, matt or rubberised finish / il fusto è disponibile con superfici lucide, satinare o gommate

galvanic process used to chrome the ABS push-button / la cromatura del tappino in ABS è ottenuta con trattamento galvanico

rubberised barrel versions are only printable on the clip / le versioni con fusto gommato sono stampabili solo su clip

PX40 – RECYCLED PLASTIC  
PLASTICA RICICLATA

Small imperfections and slight colour variations are to be considered intrinsic features of the recycled material deriving from the post-consumer sector. / Piccole imperfezioni e lievi variazioni cromatiche sono da considerarsi caratteristiche intrinseche del materiale riciclato derivante dal post-consumo.

**Fast Dry Gel** blue and black ink available on request /  
Refill Gel Fast Dry blu e nero disponibile su richiesta



The entire Maxema collection is available in recycled plastic on request /  
Tutta la collezione Maxema è realizzabile in plastica riciclata su richiesta

**TAKE IT SAFE,  
TAKE IT EASY.**

Pixel is available in white antibacterial plastic /  
La penna Pixel è disponibile in plastica antibatterica bianca

# Bay

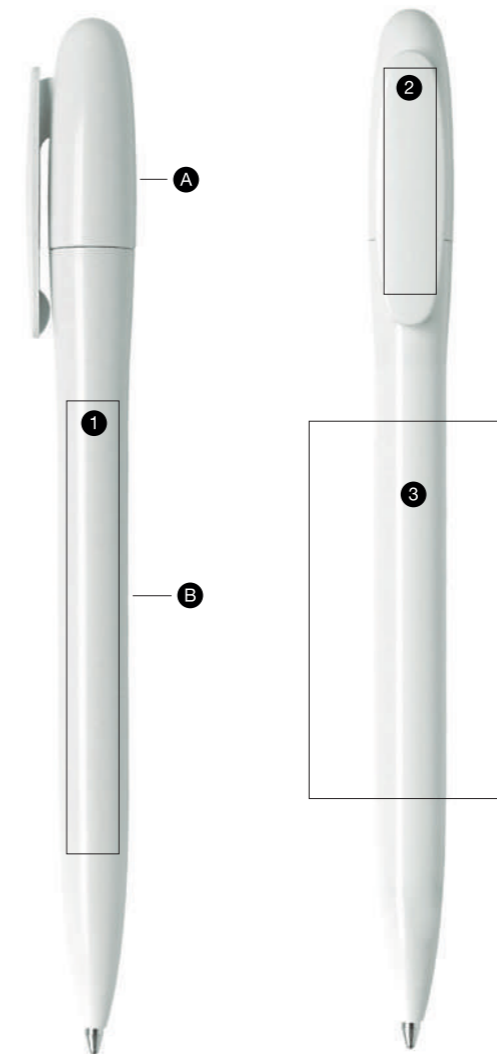

## Components / Componenti

- A Cap / cappuccio
- B Barrel / fusto

## Print area / Area stampabile

- 1 pad printing / tampografia 60 x 7 mm
- 2 pad printing / tampografia 30 x 7 mm
- 3 screen printing / serigrafia 50 x 28 mm

## Features / Caratteristiche

twist-action / meccanismo a rotazione

made of non-toxic, highly resistant ABS plastic / realizzata in plastica ABS, atossica e ad alta resistenza

X-20 refill, blue and black ink / refill X-20, inchiostro blu e nero

available in glossy or matt finish / disponibile con superfici lucide o satinare

B500 – RECYCLED PLASTIC  
PLASTICA RICICLATA

Small imperfections and slight colour variations are to be considered intrinsic features of the recycled material deriving from the post-consumer sector. / Piccole imperfezioni e lievi variazioni cromatiche sono da considerarsi caratteristiche intrinseche del materiale riciclato derivante dal post-consumo.



The entire Maxema collection is available in recycled plastic on request /  
Tutta la collezione Maxema è realizzabile in plastica riciclata su richiesta

**TAKE IT SAFE,  
TAKE IT EASY.**

Bay is available in white antibacterial plastic /  
La penna Bay è disponibile in plastica antibatterica bianca

**Fast Dry Gel** blue and black ink available on request /  
Refill Gel Fast Dry blu e nero disponibile su richiesta

# Packaging

p. 276

# Sales support *Supporti di vendita*

p. 280

# Inks and refills *Inchiostri e refill*

p. 288

# Packaging

## MY CASE



### Pad printing / tampografia

- ❶ 4,2 x 16,6 cm
- ❷ 4,3 x 14,8 cm

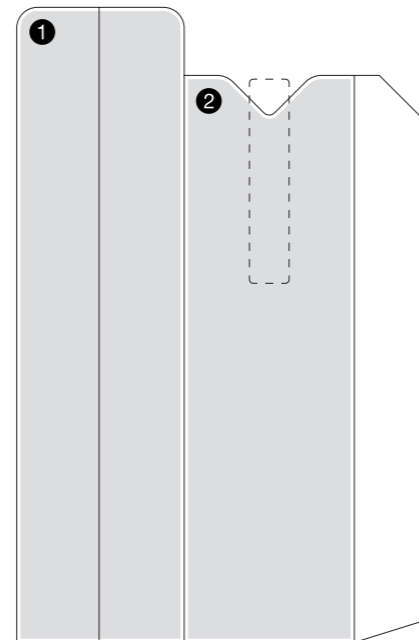

universal single pen case in  
Fedrigoni Ultra Black 280 g/m<sup>2</sup> card,  
personalisable with pad printing

size: 4,4 x 16,8 cm

—  
*astuccio universale per penna singola  
in cartoncino Fedrigoni Ultra Black 280  
gr/m<sup>2</sup>, personalizzabile con stampa  
tampografica*

dimensioni: 4,4 x 16,8 cm

## MY BOX



### Pad printing / tampografia

- ❶ 14,8 x 2 cm
- ❷ 14,9 x 2 cm
- ❸ 14,8 x 2 cm
- ❹ 14,8 x 2 cm

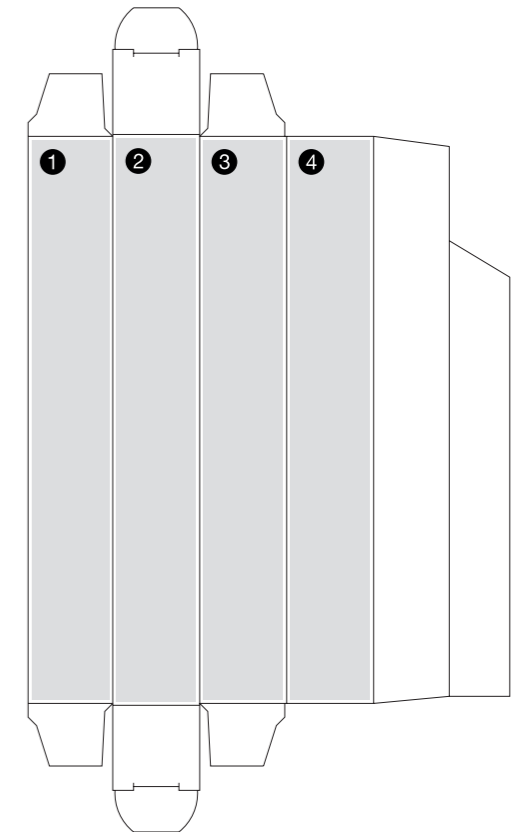

universal reclosable single pen case in  
Fedrigoni Ultra Black 280 g/m<sup>2</sup> card,  
personalisable with pad printing

size: 2,3 x 15,1 x 2,3 cm

—  
*astuccio universale richiudibile per  
penna singola in cartoncino Fedrigoni  
Ultra Black 280 gr/m<sup>2</sup>, personalizzabile  
con stampa tampografica*

dimensioni: 2,3 x 15,1 x 2,3 cm

# Packaging

## MY BOX — RECYCLED



Una penna in plastica riciclata  
si merita un packaging eco-friendly.

**A RECYCLED  
PLASTIC PEN  
DESERVES  
ECO-FRIENDLY  
PACKAGING.**

### Pad printing / tampografia

- ① 14,8 x 2 cm
- ② 14,9 x 2 cm
- ③ 14,8 x 2 cm
- ④ 14,8 x 2 cm

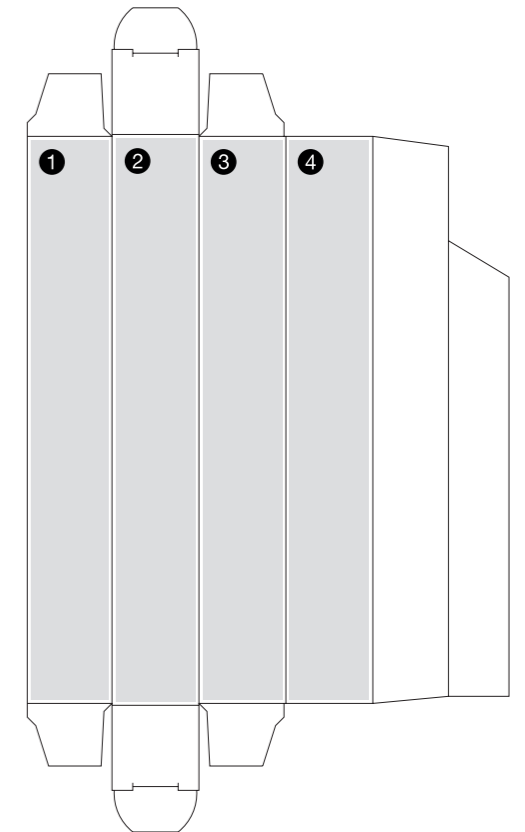

universal reclosable single pen case in Fedrigoni recycled paper Kraft, Clay and Ardesia 250 g/m<sup>2</sup> card, personalisable with pad printing

size: 2,3 x 15,1 x 2,3 cm

—  
astuccio universale richiudibile per penna singola in cartoncino Fedrigoni riciclato Kraft, Clay e Ardesia 250 g/m<sup>2</sup>, personalizzabile con stampa tampografica

dimensioni: 2,3 x 15,1 x 2,3 cm

# Minikit

## ANTIBACTERIAL



Monochromatic presentation of the Antibacterial collection: white has always been a symbol of safety and protection.

*Presentazione monocromatica della collezione Antibacterial: il bianco è da sempre simbolo di sicurezza e protezione.*



5 antibacterial printed pens in white colour

size: 10,2 x 19 cm (closed format)

5 penne antibatteriche bianche

dimensioni: 10,2 x 19 cm (formato chiuso)

## GENERAL / GENERICO



The essential selection of our best sellers: Minikits are valuable tools to display, consult and collect.

*La selezione essenziale dei nostri best seller: i Minikit sono strumenti preziosi da esporre, consultare, collezionare.*



5 printed pens in assorted colours of the most representative models

size: 14,7 x 19 cm (closed format)

5 penne stampate in colori assortiti dei modelli più rappresentativi

dimensioni: 14,7 x 19 cm (formato chiuso)

# Minikit

## 8 RECYCLED PENS



For our recycled plastic pens samples we have chosen sustainable packaging made up of cellulose, certified recycled fibres and cotton fibres. FSC certification guarantees that the entire wood-paper supply chain derives from environmentally friendly, socially useful and economically sustainable forest management.

contains 8 pens of one model, in all available colours  
 size: 24,3 x 20 cm (closed format)  
 —  
 contiene 8 penne di un modello, in tutti i colori disponibili  
 dimensioni: 24,3 x 20 cm (formato chiuso)

# Minikit

## 6 RECYCLED PENS



Per i campionari delle nostre penne in plastica riciclata abbiamo scelto un packaging sostenibile composto da cellulosa, fibre di riciclo certificate e fibre di cotone. La certificazione FSC garantisce che l'intera filiera legno-carta derivi da una gestione forestale rispettosa dell'ambiente, socialmente utile ed economicamente sostenibile.

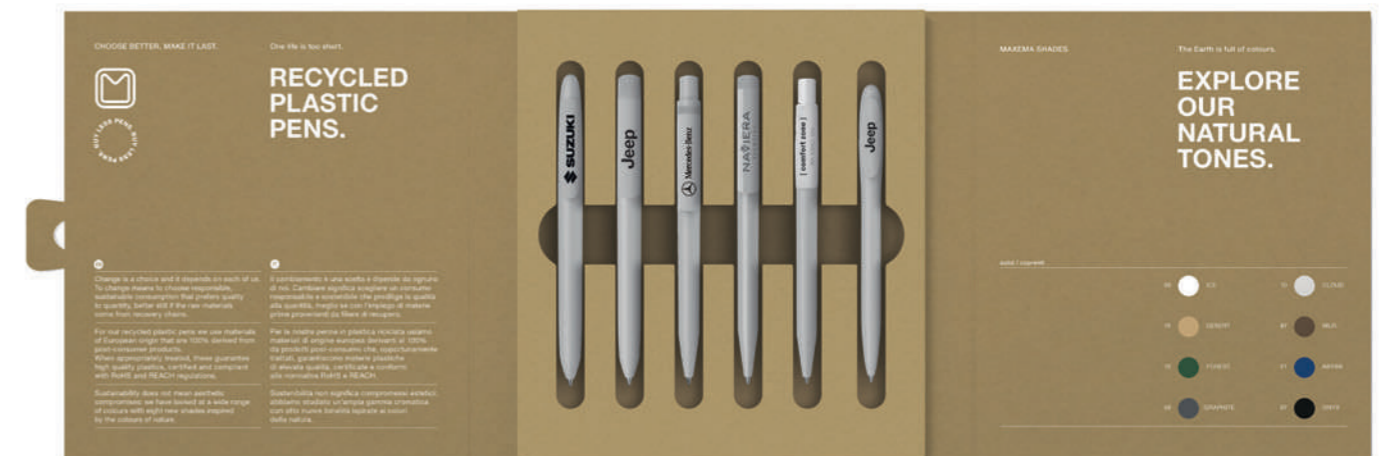

contains 6 different recycled plastic models:  
 Icon Pure, Flow Pure, Dot, Zink, Pixel and Bay  
 size: 19 x 19,8 cm (closed format)  
 —  
 contiene 6 diversi modelli di penne in plastica riciclata:  
 Icon Pure, Flow Pure, Dot, Zink, Pixel e Bay  
 dimensioni: 19 x 19,8 cm (formato chiuso)

# Minikit

## MOOD METAL



Metal elegance in 3 different finishes and clip available in 23 shades.

*L'eleganza del metallo in 3 diverse finiture e clip disponibile in 23 colorazioni.*



3 Mood Metal in chrome, titanium grey and gold finish

size: 10,2 x 19 cm (closed format)

3 Mood Metal nelle finiture: cromato, grigio titanio e oro

dimensioni: 10,2 x 19 cm (formato chiuso)



# Kit and box sets / Kit e raccoglitori

## KIT

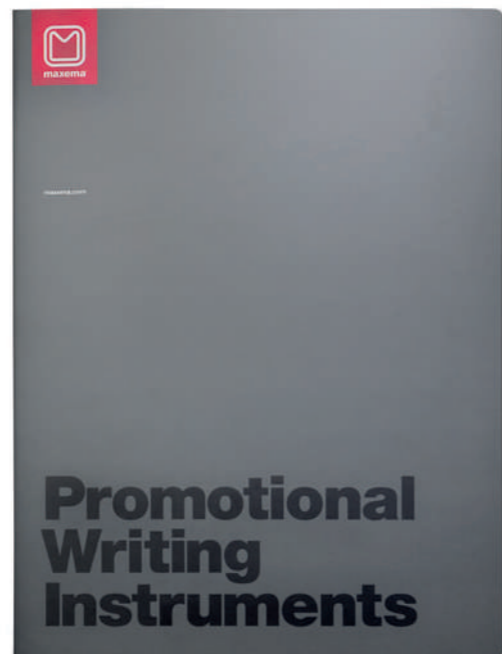

20 printed pens in assorted colours of the most representative models

size: 25 x 34 cm (closed format)

—  
20 penne stampate in colori assortiti dei modelli più rappresentativi

dimensioni: 25 x 34 cm (formato chiuso)

## BOX SETS / RACCOGLITORI

The Kits are available in 1, 2 or 3 unit box sets / i Kit sono disponibili in raccoglitori da 1, 2 o 3

- ❶ 28 x 33 x 3 cm
- ❷ 28 x 33 x 5,5 cm
- ❸ 28 x 33 x 8 cm

## MODEL KIT / KIT MODELLO

20 printed pens in assorted colours of a single model size: 25 x 34 cm (closed format)

—  
20 penne stampate in colori assortiti di un unico modello dimensioni: 25 x 34 cm (formato chiuso)

—  
the Model Kit is available for / il Kit Modello è disponibile per:  
Icon Pure, Mood Metal, Dot Antibacterial, Mood, Flow Pure, Flow, Dot, Zink, View, Tag, Icon, Icon Green, Tag Green, Ethic, Pixel, Next, Bay.



On request we can prepare customised sets of samples containing specific versions and colours of pens.

—  
Su richiesta possiamo realizzare campionari personalizzati con penne di specifiche versioni e colori.



# Inks and refills / *Inchiostri e refill*

## INKS / INCHIOSTRI



blue  
blu



black  
nero

### X-20



tungsten carbide ball Ø 1 mm, length 107 mm, for up to 2000 meters of writing  
*sfera in carburo di tungsteno Ø 1 mm, lunghezza 107 mm, fino a 2000 metri di scrittura*

### JUMBO



tungsten carbide ball Ø 1 mm, length 107 mm, for up to 2500 meters of writing  
*sfera in carburo di tungsteno Ø 1 mm, lunghezza 107 mm, fino a 2500 metri di scrittura*

### RT 90 PARKER TYPE / TIPO PARKER



tungsten carbide ball Ø 0,8 mm, length 98 mm, for up to 4000 meters of writing  
*sfera in carburo di tungsteno Ø 0,8 mm, lunghezza 98 mm, fino a 4000 metri di scrittura*

### RT 90 ON DEMAND / SU RICHIESTA



tungsten carbide ball Ø 1 mm, length 98 mm, for up to 4000 meters of writing  
*sfera in carburo di tungsteno Ø 1 mm, lunghezza 98 mm, fino a 4000 metri di scrittura*

### GEL FAST DRY ON DEMAND / SU RICHIESTA



titanium carbide ball (SS, TC), Ø 0.7 mm, tip in stainless steel, length 98 mm, up to 700 meters of writing  
*sfera in carburo di titanio (SS, TC) Ø 0,7 mm, punta in acciaio inox, lunghezza 98 mm, fino a 700 metri di scrittura*

The refill's barrel is made of polypropilene, the tip is made of nickel-plated brass. The non-toxic ink is Dokumental. All Dokumental inks comply with European REACH and American TSCA standards.

—  
*Il tubetto del refill è in polipropilene, la punta è in ottone nichelato. L'inchiostro, atossico, è Dokumental. Tutti gli inchiostri Dokumental sono conformi alla normativa europea REACH e americana TSCA.*

The refill's barrel is made of polypropilene, the tip is made of nickel-silver brass. The non-toxic ink is Dokumental. All Dokumental inks comply with European REACH and American TSCA standards.

—  
*Il tubetto del refill è in polipropilene, la punta è in nichel-silver. L'inchiostro, atossico, è Dokumental. Tutti gli inchiostri Dokumental sono conformi alla normativa europea REACH e americana TSCA.*

Water-based, non-toxic gel ink, produced in Italy and compliant with European REACH and American TSCA standards. The refill's barrel is made of polypropilene.

—  
*Inchiostro gel a base acqua, atossico e prodotto in Italia, conforme alla normativa europea REACH e americana TSCA. Il tubetto del refill è in polipropilene.*

all rights reserved maxema srl  
tutti i diritti riservati maxema srl

The brands mentioned in this catalogue are the exclusive property of the respective owners. They are used for purely illustrative purposes and cannot be the object of any buying and selling transactions, under any circumstances.

*I marchi menzionati in questo catalogo sono di proprietà esclusiva dei rispettivi proprietari. L'utilizzo dei suddetti marchi è a puro titolo esemplificativo e non potrà mai, in alcun caso, essere oggetto di trattative commerciali.*

art direction and graphic design  
undesign.it

still life  
infiniostudio.com

editing  
elena ambrosio  
sara zampedri



♻️ RECYCLED PLASTIC PENS / PENNE IN PLASTICA RICICLATA — solid / coprenti

- |             |          |           |        |           |          |
|-------------|----------|-----------|--------|-----------|----------|
| 06 ice      | 10 cloud | 76 desert | 87 mud | 19 forest | 21 abyss |
| 58 graphite | 07 onyx  |           |        |           |          |

solid / coprenti

- |                 |                       |                              |                            |                        |                                 |
|-----------------|-----------------------|------------------------------|----------------------------|------------------------|---------------------------------|
| 01 white bianco | 70 cream crema        | 03 yellow giallo             | 18 orange arancio          | 15 red rosso           | 74 burgundy bordeaux            |
| 60 pink rosa    | 61 magenta magenta    | 71 light violet viola chiaro | 25 dark violet viola scuro | 72 leather cuoio       | 73 brown marrone                |
| 79 lime lime    | 09 green verde        | 75 verde scuro dark green    | 26 aquamarine acquamarina  | 27 octan green ottanio | 64 pastel blue azzurro pastello |
| 77 cyan ciano   | 12 light blue azzurro | 22 blue blu                  | 05 grey grigio             | 04 black nero          |                                 |

transparent / trasparenti

- |                   |                           |                            |                |                  |                             |
|-------------------|---------------------------|----------------------------|----------------|------------------|-----------------------------|
| 39 neutral neutro | 52 yellow giallo          | 53 orange arancio          | 45 red rosso   | 59 pink rosa     | 41 magenta magenta          |
| 31 lilac lilla    | 51 violet viola           | 55 dark violet viola scuro | 37 amber ambra | 38 brown marrone | 78 lime lime                |
| 49 green verde    | 47 aquamarine acquamarina | 34 light blue azzurro      | 67 cyan ciano  | 44 blue blu      | 30 light grey grigio chiaro |
| 40 grey grigio    | 50 dark grey grigio scuro |                            |                |                  |                             |

solid Icon green and Tag green / Icon green e Tag green coprenti

- |                 |                           |                  |                   |               |                  |
|-----------------|---------------------------|------------------|-------------------|---------------|------------------|
| 01 white bianco | 70 cream crema            | 42 yellow giallo | 43 orange arancio | 35 red rosso  | 13 brown marrone |
| 29 green verde  | 65 verde scuro dark green | 77 cyan ciano    | 54 blue blu       | 04 black nero |                  |

metallic paintings / vernici metallizzate

- |                |                  |                |                         |                     |                            |
|----------------|------------------|----------------|-------------------------|---------------------|----------------------------|
| 91 pearl perla | 92 gold oro      | 83 copper rame | 85 red rosso            | 81 violet viola     | 82 dark violet viola scuro |
| 89 green verde | 94 aviation avio | 95 blue blu    | 96 anthracite antracite | aluminium alluminio |                            |

solid fluo / fluo coprenti

- |                  |                   |                            |                   |                |
|------------------|-------------------|----------------------------|-------------------|----------------|
| 02 yellow giallo | 17 orange arancio | 14 coral red rosso corallo | 56 fuchsia fucsia | 08 green verde |
|------------------|-------------------|----------------------------|-------------------|----------------|

transparent fluo / fluo trasparenti

- |                  |                   |                            |                   |                |
|------------------|-------------------|----------------------------|-------------------|----------------|
| 20 yellow giallo | 33 orange arancio | 24 coral red rosso corallo | 46 fuchsia fucsia | 48 green verde |
|------------------|-------------------|----------------------------|-------------------|----------------|

galvanic process / trattamento galvanico

- |                |             |
|----------------|-------------|
| chrome cromato | gold dorato |
|----------------|-------------|

metal finishes / finiture metallo

- |          |                |                    |                              |
|----------|----------------|--------------------|------------------------------|
| gold oro | chrome cromato | rose gold oro rosa | titanium gray grigio titanio |
|----------|----------------|--------------------|------------------------------|



Made  
in Italy



Prodotto  
in Italia



Fabriqué  
en Italie



Fabricado  
en Italia

